

A photograph of a modern hotel room interior, viewed through a blue, textured frame that resembles a doorway or a window. The room features a bed with white linens on the left, a brown patterned rug in the center, and a seating area with a sofa and coffee table on the right. A window with brown curtains is visible in the background. The lighting is soft and natural, coming from the window.

KNX HOTEL SOLUTIONS **ekinex**

INTRODUCTION

Accommodation facilities	05
Sector	07
Ekinex for the hotel buildings	09
The KNX standard	11

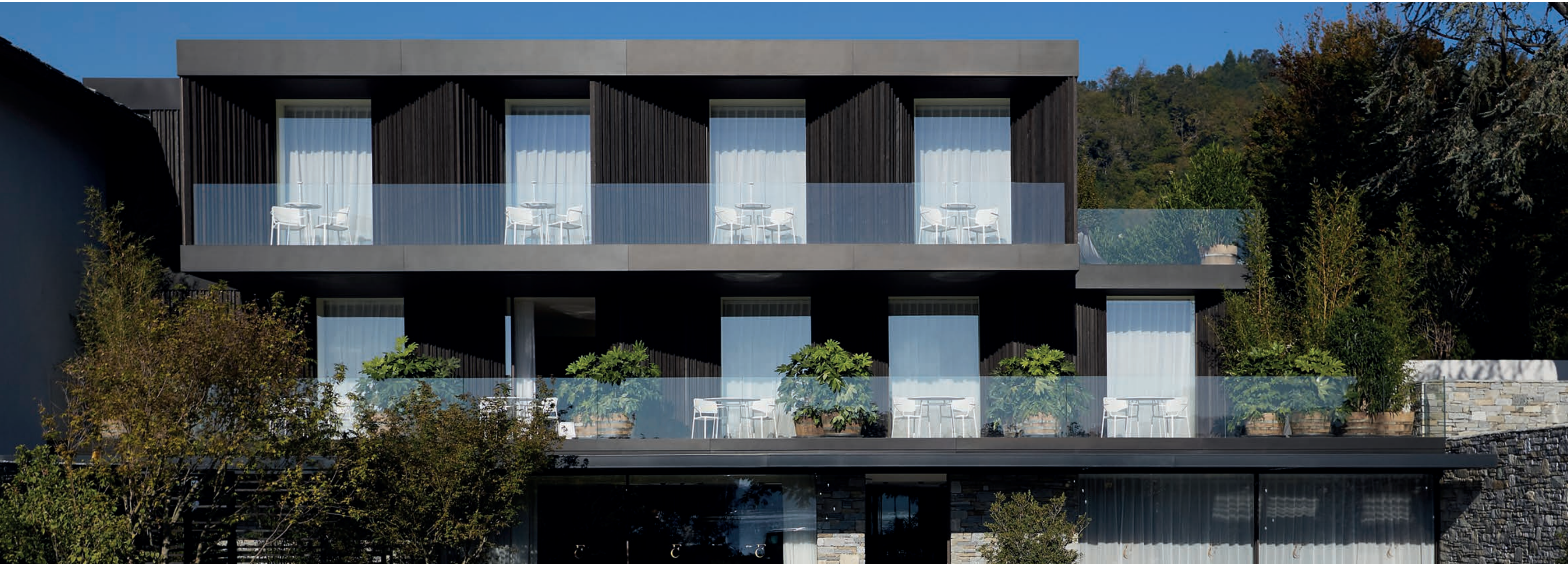

Accommodation facilities

There are no other types of buildings that have such diverse and complex requirements as accommodation facilities and this for a number of reasons due to the function they perform and the objectives for which they are built and managed. First of all, this category includes a great variety of activities, linked by the fact that they offer organised hospitality: besides the classic hotels there are residences, distributed hotels, bed & breakfasts and holiday farms, congress and spa centres, motels and guesthouses, tourist villages and holiday homes: many needs in common with these also have other buildings such as university campuses, residences for the elderly, guest houses or hostels. By its very nature, accommodation is uniformly distributed throughout the territory: the facilities are located in almost every geographical and climatic area: from the high mountains to the coastal areas of lakes and seas, passing through medieval villages and metropolitan centres, rural areas and cities of art. Each structure has particular needs, depending on the type of hospitality offered: for tourist, work or study reasons; for short or prolonged periods; for local

or international guests; for seasonal employment. Some of these facilities consist of a single building, others of a group of buildings, even with different uses. In addition to areas for individual use, such as guest rooms, there are areas open to the public, such as lobbies, bars, restaurants or conference rooms. More and more hotels are also equipped with swimming pools, spas, fitness areas or wellness centres. Finally, it should not be forgotten that these facilities are also places of work and include offices, technical rooms and areas reserved for service personnel. In addition to all this, there are the contemporary requirements of buildings: a high class of energy efficiency, comfort and well-being in all possible situations, environmental sustainability, low operating costs and easy maintenance. With such a variety of situations and complex requirements, only a flexible and high-performance building automation system such as Ekinex, based on the open KNX standard, can provide adequate answers and tailor-made solutions.



Sector

The hotel business is one of the main sectors of the world economy, both in terms of employment and direct contribution to gross domestic product; the long-term trend also shows that international tourism demand is growing at higher rates than the economy itself. In the European Union the hospitality sector is, together with tourism, the third most important socio-economic activity; in 2017 this geographical area confirmed itself as the largest tourist destination with 672 million international arrivals. The dynamism of the sector has allowed a significant increase in the number of businesses and employees in recent years, with the creation in the countries of the old continent of 1,6 million new jobs in the period 2013-2016; the positive impact on employment has even proved vital in rural areas and far from the major directions of international trade. In this sector, Italy is among the most important European countries: it occupies the first place for number of hotel rooms, the third place for

number of overnight stays and is the country with the greatest capacity to attract tourists from non-EU countries. However, the hotel sector is also extremely important as an investment driver for other sectors of the economy, such as construction, plant engineering or furnishings, thanks to the constant process of restructuring and upgrading of facilities, necessary to maintain a high level of competitiveness and better meet the growth of guests' needs. Hotels are currently moving towards higher levels with an increase in average size, a progressive migration towards medium-high categories and a growing offer of innovative and personalized services. Today the sector is facing the challenges of our time: maximising the positive effects of tourism on the economic, social and cultural side, minimising the negative consequences and promoting sustainability in all its aspects.



Ekinex solutions for hotel buildings

Ekinex, the Italian company specializing in the development of KNX standard devices, offers advanced solutions for the automation of accommodation facilities, designed to provide guests with comfort and environmental quality and managers and owners with high energy efficiency.

Solutions specifically dedicated to the hotel sector include the access control and presence detection system, completed by the Accédo software suite for programming and management of typical hotel functions and the hotel module for controlling all room functions. In addition to these products, there is a wide range of KNX standard devices for building automation that extends the possibilities and allows the automation of all hotel rooms in an integrated way: lobby and reception area, common areas, conference rooms, bar and restaurant, spa and fitness area, garage and staff offices.

In medium and large structures there are several buildings, interconnected with each other, with different uses and services, and complex requirements that can only be met by a flexible and interoperable automation system such as Ekinex, developed according to the KNX standard and easily interfaced with other widely used systems and protocols.

In the Ekinex devices there are a series of functions dedicated to energy saving and quality of indoor environment that are particularly useful for hotels that are developed according to the criteria of green buildings and are subject to the certification process of sustainability and environmental well-being.



The KNX standard

Major developments in the field of building automation have been possible above all thanks to the definition of an open, modular and interoperable standard such as KNX. The standard is characterized by full compliance with the EN 50090 standard on Home and Building Electronic Systems (HBES). The presence on the market of this standard since 1991 offers the greatest guarantees in terms of reliability and consolidation of the technology used. The opening of the standard and KNX Association, on the other hand, ensures the availability of products in the long term and a constant development both in terms of technology and the offer of products, functions and applications. For customers, the variety and availability of KNX products is unparalleled in other areas of technology and the openness of the system results in maximum freedom of choice and avoids the disadvantageous dependence of purchasing from a single manufacturer.

Thanks to the modularity of the system, the system can be expanded over time, starting with a basic configuration and adding other functions later on.

Achievable savings with the adoption of the KNX system for Home & Building control:

- **40% over shutters control**
- **50% over individual ambient control**
- **60% over ambient lighting control**
- **60% over ventilation control**



The KNX standard is entirely compliant with the EN 50090 standard on HBES (Home and Building Electronic Systems)

HOTEL SOLUTIONS

Solutions for hotel buildings

Devices for control access and presence detection	14
Accédo software	21
Hotel module	24
Pushbuttons	26
Delégo supervision	34



Devices for control access and presence detection

KNX devices series for controlled access to rooms and for detection of presence by means of smart-cards. Ideal for creating KNX standard automation functions in hospitality and hospitality structures (hotels, residences, guesthouses or bed & breakfasts) with the aesthetic uniformity of Ekinex® wall products (pushbutton and room thermostats), in combination with products from switchboard (EK-H01-TP and EK-HU1-TP controllers) and with the Ekinex® Accédo management and supervision software.

The products are equipped with an RFID-type front antenna capable of feeding the smart-card that is approached and reading the programmed information. The EK-TR2-TP **(a)** card reader enables access following validation of the card based on the configured authorizations. The EK-TH2-TP **(b)** card holder activates presence following the insertion of the card in the appropriate front pocket. Both products can manage guest cards of the accommodation facility, based on the system codes, the reservation and the check-in / check-out period, service cards based on time slots and pass-dates. To program cards, use the device EK-TP2-TP, which is very similar

to the card reader with the possibility of activating the front antenna also for writing operations.

The programming of the cards in the reception area as well as the activation of a card reader outside the room and a card holder inside takes place on the KNX network infrastructure. In addition to the power supplied by the KNX bus, an external auxiliary power supply is required for the RFID antenna at 12/24 Vac / dc. The basic programming of the devices as well as the configuration of the automation functions is carried out through the ETS application program; card programming and enabling room and controlled access devices in common areas requires the use of Ekinex® Accédo management and supervision software. Both devices can notify the passage and validation events of each type of card via the KNX bus with an internal buffer to cope with the unavailability of the communication bus due to excessive data traffic.

The use of Ekinex® temperature control devices in combination with the system for access and presence detection, makes it possible to offer guests of a hotel maximum comfort and, at the same time, to safeguard the objectives of energy efficiency and cost savings defined in the technical and economic planning.



Card reader

ACCESS CONTROL

Description

The EK-TR2-TP card reader with RFID technology is used for access control in combination with the EK-TH2-TP card holder. Equipped with a bi-stable relay (4A@24Vac/dc), an input for potential-free contacts and a 3-colour front signal LED (white, green and red). The device has an integrated KNX bus communication module and is designed for wall mounting in a flush-mounted box; it is supplied with SELV voltage via the KNX bus and requires an auxiliary power supply at 12-24 Vac/dc.

Functionality

- Access control via KNX TP bus (twisted pair)
- Enabling access after card validation
- Management of the guest based on the booking and the check-in / check-out time; management of users based on time slots and passe-partouts
- Programmable output for electric lock activation or as simple actuator activated by KNX telegrams
- Validation in progress signalling (green led) or unauthorized card (red led); possibility of enabling the " don't disturb" or "camera remake" commands
- Notification of validation events to supervisory system with memory buffer

Technical data

- 1 relay 4A @24V AC/DC
- 1 input (NO) for free-potential contacts
- Power supply 30 Vdc from KNX bus
- Auxiliary power supply 12-24 AC/DC
- Wall-mounting in round flushing box (60 mm distance between fixing holes)
- Degree of protection IP20 according to EN 60529 (product installed)
- Dimensions: 44 x 44 x 43 mm (W x H x D)

Dimensions [mm]

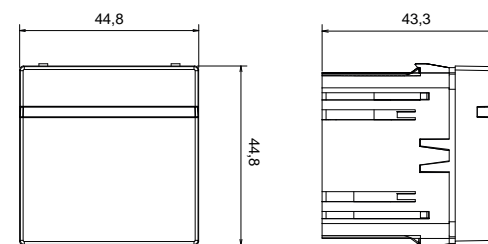

Order information

Code	Mounting / accessories
EK-TR2-TP	square plate with 45x45 mm window optional frame of Form or Flank series



Configuration and commissioning

Ekinex® Accédo software for programming access control functions and cards.
Project file: **APEKTRTPH2TP##.knxproj** (downloadable from www.ekinex.com)



Documentation

For more information see the technical documentation, download from www.ekinex.com



Card holder

PRESENCE DETECTION

Description

The EK-TH2-TP card holder with RFID technology is used for presence detection in combination with the EK-TR2-TP card reader. Equipped with a bistable relay (4A@24Vac/dc), an input for potential-free contacts and a front signal LED (white). The luminaire has an integrated KNX bus communication module and is designed for wall mounting in a flush-mounted box; it is supplied with SELV voltage via the KNX bus and requires an auxiliary power supply at 12-24 Vac/dc.

Functionality

- Presence detection via bus and communication to supervision system via KNX TP bus (twisted pair)
- Enabling presence after inserting the card into the front pocket
- Guest management of the structure according to the booking and the check-in / check-out period; user management according to time slots and passe-partouts
- Output programmable according to card validation or as actuator activated by KNX telegrams. Delay to card extraction configurable for courtesy light management
- Binary input available for connection of conventional button (with switching, dimming or roller shutter / curtains function) or signal contact (e.g. window opening)
- White front LED: flashing when the card is not inserted, off when the card is inserted; LED control via KNX bus telegrams possible
- Notification of presence events detected to supervision system with memory buffer

Technical data

- 1 relay 4A @24V AC/DC
- 1 input (NO) for free-potential contacts
- Power supply 30 Vdc from KNX bus
- Auxiliary power supply 12-24 AC/DC
- Wall-mounting in round flushing box (60 mm distance between fixing holes)
- Degree of protection IP20 according to EN 60529 (product installed)
- Dimensions: 44 x 44 x 43 mm (W x H x D)

Dimensions [mm]

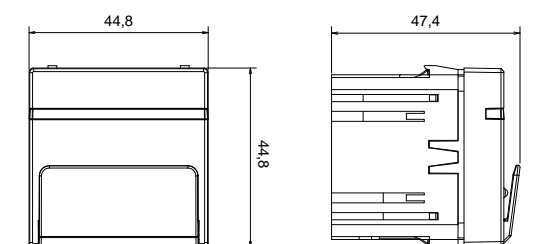

Order information

Code	Mounting / accessories
EK-TH2-TP	square plate with 45x45 mm window optional frame of Form or Flank series



Configuration and commissioning

Ekinex® Accédo software for programming access control functions and cards.
Project file: **APEKTRTPH2TP##.knxproj** (downloadable from www.ekinex.com)



Documentation

For more information see the technical documentation, download from www.ekinex.com



Card programmer

ACCESSORIES



Description

The EK-TP2-TP card programmer with RFID technology is used for programming cards to be used with the EK-TR2-TP card reader and the ekinex EK-TH2-TP card holder. Equipped with a bi-stable relay (4A@24Vac/dc) and an input for potential-free contacts the device has an integrated KNX bus communication module and is designed to be mounted in a flush-mounted wall box; it is supplied with SELV voltage via the KNX bus and requires an auxiliary power supply at 12-24 Vac/dc.

Functionality

- Programming of cards via KNX TP bus (twisted pair) and ekinex Accédo software
- Card programming with different user profiles: guest, staff and passe-partouts
- Guest booking management and check-in/check-out operation
- Card activation based on time slots for service personnel
- Event notification to the supervision system with memory buffer

Technical data

- Power supply 30 Vdc from KNX bus
- Auxiliary power supply 12-24 AC/DC
- Mounting in table box (optional)
- Degree of protection IP20 according to EN 60529 (product installed)
- Dimensions: 44 x 44 x 43 mm (W x H x D)

Dimensioni [mm]

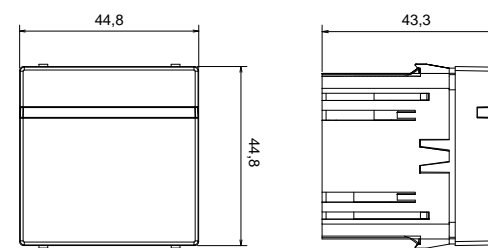

Order information

Code	Mounting
EK-TP2-TP	square plate with 45x45 mm window optional frame of Form or Flank series



Configuration and commissioning

Ekinex® Accédo software for programming access control functions and cards.
Project file: **APEKTRTPH2TP##.knxproj** (downloadable from www.ekinex.com)



Documentation

For more information see the technical documentation, download from www.ekinex.com



Smart-card

ACCESSORIES

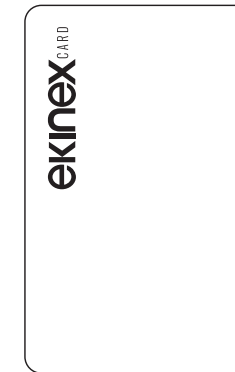

Description

Smart-card with RFID technology to be used with the EK-TR2-TP reader and the EK-TH2-TP card holder for access control and presence detection in accommodation and hospitality facilities (hotels, residences, guest houses or bed&breakfast).

Main features

- Plastic material, standard dimensions 85 x 54 x 1 mm (W x H x D)
- Maximum non-contact recognition distance with EK-TR2-TP reader: 3-5 cm

Order information

Code	Customization	Package
EK-TCE-10	Ekinex® logo in black colour	10 pcs.
EK-TCC-10	personalized with customer logo	on request



Configuration and commissioning

The **EK-TP2-TP** card programming device and the **Ekinex® Accédo software**, dedicated to the management of accommodation and hospitality facilities, are required for card programming.





Accédo Suite

SOFTWARE

Ekinex Accédo is the software for hotel applications developed to work in an integrated way with the KNX building automation system. ETS (Engineering Tool Software) projects can be imported directly into Accédo.

The main functions of Accédo:

- Programming of smart-cards using RFID technology. Communication between the Accédo software and the programmer(s) in reception, readers outside the room or outside the entrances to common areas and card holder inside the room, it is done through the KNX bus
- Room reservation planning operations and activities check-in/check-out for guests and service staff
- Execution of scenarios and schedules to execute a sequence of operations using a single command. The same operations can be scheduled to be executed on predefined days and times
- Possibility of using an astronomical clock software configured according to latitude and longitude of the site
- System supervision via configurable graphic pages
- Management of technological alarms
- Reporting of all accesses to the structure

Accédo has three gateways, integrated as Windows services, to communicate with devices using the following communication protocols :

- **KNX TP** (through USB interface or KNX/NetIP)
- **Modbus master** (serial with USB RTU/ASCII interface and TCP/IP)
- **M-Bus** (serial with USB interface, for acquisition of consumption data)

Accédo offers seven access profiles according to the credentials entered at startup, maintaining a common interface and differentiating functions for each profile:

- Administrator
- Manager
- Supervisor plus
- Supervisor
- Maintainer
- User plus
- User

Accédo software

PROGRAMMING SOFTWARE



Description

Software for the integrated management of technological systems, particularly suitable for accommodation and hospitality facilities (hotels, residences, guest houses or bed & breakfast). Multi-client-server architecture with HTML5 web server functionality. Programming of transponder cards for access control, presence detection and (optional) electronic money functionality. Automatic import of ETS projects with easy and intuitive creation of graphic pages, drag&drop functionality, advanced copy/paste and undo/redo. Integrated management of calendars, scenarios and schedules. Interface to other communication protocols such as BACnet, Modbus, M-Bus, etc.

The desktop interface of Accédo looks like a single-document Windows application. In the left section there is the vertical toolbar; by selecting an item in the vertical section, you can access the horizontal toolbar at the top. This allows you to access the central workspace of the card. The vertical toolbar sections are shown on the next page.

Requirements

- Operating system: Microsoft Windows® 7 or later (recommended: Windows® 10. In server environment you can use Windows® Server 2016 (in its Basic, Standard, Professional or Business versions) or later - I/O RS232
- Processor: Intel Core i5 3.3 GHz or higher
- RAM memory: 4 GB minimum, 8 GB for server installation
- Hard disk: at least 40 GB free for server installation
- SSD: 240 GB
- Monitor: Full HD



Documentation

For more information see the technical documentation, download from www.ekinex.com



Order information

Code	Description
EK-ACC-SW	Transponder Supervisor Software
EK-ACC-L12	Transponder Software License up to 12 reader
EK-ACC-L25	Transponder Software License up to 25 reader
EK-ACC-L50	Transponder Software License up to 50 reader
EK-ACC-L100	Transponder Software License up to 100 reader
EK-ACC-L200	Transponder Software License up to 200 reader
EK-ACC-LC	Accédo Client License for additional programming workstation



Planner

Accédo's Planner section provides the operator at the reception desk with an immediate graphical tool to keep track of guests' booking schedules. The operator with the enabled user profile can enter new bookings graphically, registering the guest and fixing the period of stay in the accommodation facility.

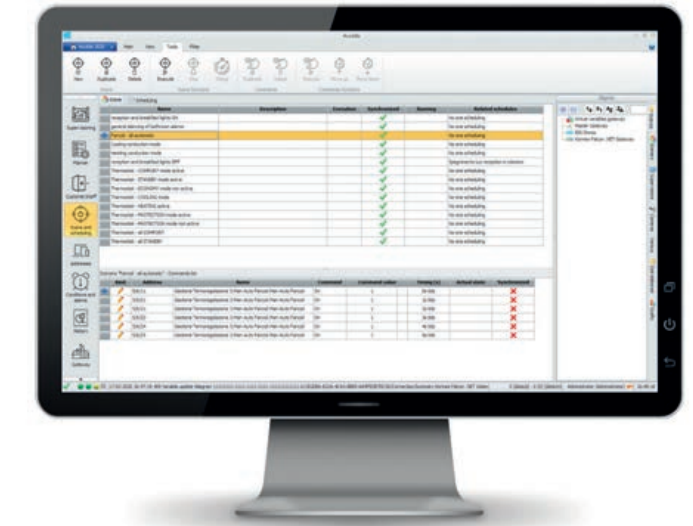

Scenarios and schedules

In the section Scenarios and schedules of Accédo complex sequences, such as on/off or energy saving activation in the guest rooms, are easily grouped into scenarios that can be called up manually by the operator at the reception desk or activated automatically at set times of the day. Accédo has an integrated astronomical clock, configurable through the geographical coordinates of the accommodation facility, which provides scheduled events at the time of sunrise and sunset.



Guest / Staff

The Guest / Staff section of Accédo allows the programming of the cards for both guests and service staff of the structure. It is possible to easily connect the cards to the registry office, create or duplicate the cards linked to the reservation of the guests; for the service staff, passe-partout cards and cards linked to an hourly access profile are available for cleaning or maintenance of the room. By means of the KNX bus, the card enabling information is instantly communicated to the card reader and the card holder of the corresponding guest room.

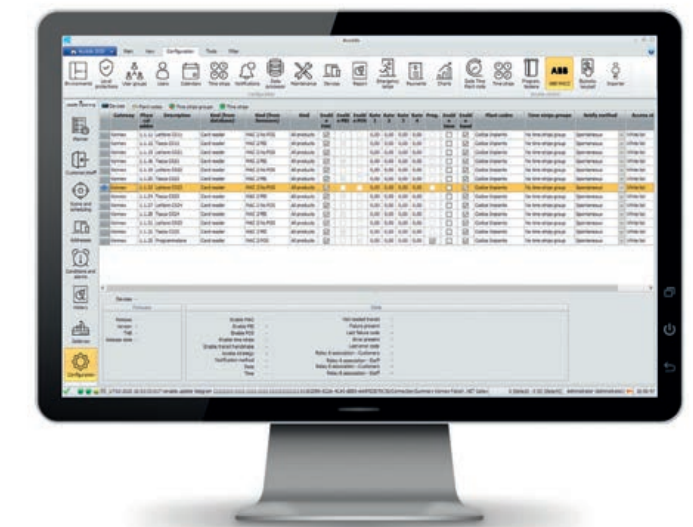

Configurations

In the Gateway and Configuration section of Accédo it is possible to configure the access control system for the whole accommodation facility. The configuration is done by directly importing the ETS project into the working environment: if the "Building" view is completed in the ETS project, all information related to rooms, technical and common areas are automatically imported into the project.

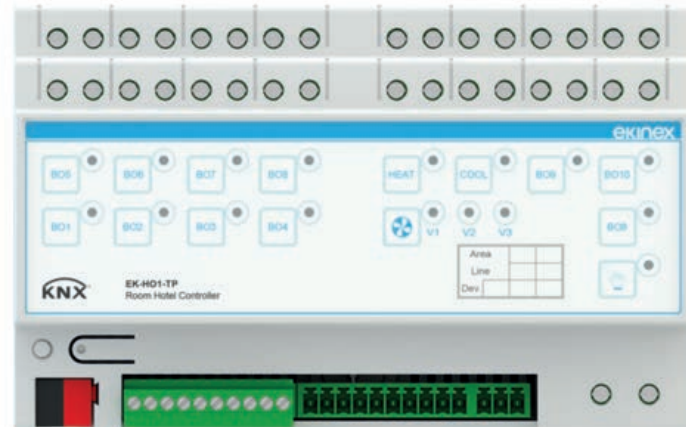

Input/output module for guest room applications

Description

The EK-H01-TP module is an extremely versatile and compact solution that integrates in a single device all the functions required for the control of the guest room: lighting, climate control, shading, control of electrical loads and input and output signals. The module is mounted on a 35 mm standard rail according to EN 60715; thanks to its very small dimensions (8 modular units, 144 mm wide), also in consideration of the many functions carried out, the module contributes to saving space in the room switchboards. In case of need, the front keypad allows manual operation.

Technical data

Input	Nr.	Use
Configurable	4	- for NTC temperature sensors (AI) or - generic use (DI, individual or coupled)
Digital (generic)	4	to be used individually or coupled
Digital (dedicated)	5	- for contact card holder - for contact external access control - for window contact or generic - for contact assistance request / emergency contact - for contact "room rearrangement"
Output	Nr.	Use
	4	individual use for ON/OFF switching of loads or coupled for roller shutters or venetian blinds, 5(3) A relay
	6	individual use for ON/OFF switching of loads, 16(10) A relay
Digital	1	for control of 1 electric lock (12/24 Vac powered), 5(3) A relay
	5	dedicated to fan-coil unit control: - 3 for 3-speed fan, 5(3) A relay - 2 for ON / OFF control of valves, 16(10) A relay
Analogic	1	for 0-10 V control of fan (with brushless motor) speed

Order information

Code	Package
EK-H01-TP	1 pcs.



SHADING

Use as KNX actuator for controlling and monitoring of motorized drives for shading devices (roller shutters, venetian blinds or curtains) or motorized doors / windows in combination with:

- Ekinex KNX pushbuttons or
- traditional (non-bus) pushbuttons of standard market series by means of special configuration of the inputs.

Main functions

- Complete run (up and down or open and close)
- Partial run (stop in position from 0 to 100%)
- Position setting
- Slat inclination adjustment (venetian blinds)
- Integration in scenarios
- Lock, forced operation
- Status indication



SIGNAL ACQUISITION

Inputs for potential-free contacts:

- door or window opening
- traditional (non bus) card reader
- traditional (non bus) card holder
- bath pushbutton
- assistance or rescue request
- room rearrangement



HEATING AND COOLING

Use as KNX actuator for fan-coil units in combination with an Ekinex room thermostat. Use as KNX actuator-controller (integrated controller) for fan-coil units in combination with:

- KNX sensors (temperature value received via bus) or
- NTC temperature sensors (temperature value acquired through a specific input configuration).

Main functions

- 3-speed or 0-10V fan control with brushless motor and inverter board
- ON/OFF control of one valve or two valves respectively for 2 or 4 pipe distribution
- Local or centralised heating / cooling switching
- Automatic heating/cooling attenuation at window opening
- Starting the fan according to the actual water temperature (hot-start / cold-start)
- Fan activation in case of air stratification (large volume rooms)
- Condensation level monitoring
- Hours of operation monitoring with filter replacement signaling



LIGHTING AND OTHER ELECTRICAL LOADS

Use as KNX actuator for ON / OFF switching of luminaires or other electrical loads in combination with:

- Ekinex KNX pushbuttons or
- traditional (non-bus) pushbuttons of standard market series by means of special configuration of the inputs.



DOOR LOCK CONTROL

Output for sending impulses to an electrical lock for use in combination with:

- an Ekinex card reader or
- a traditional (non-bus) card reader with signalling contact connected to an input configured for this purpose;
- other KNX devices (by receiving a communication object on the bus)



Configuration and commissioning

By means of ETS4 2.0 software (or later versions)
Application program: **APEKH01TP##.knxprod**
(## = version, downloadable from www.ekinex.com)



Documentation

For more information see the technical documentation, download from www.ekinex.com



Input/output module for hotel applications

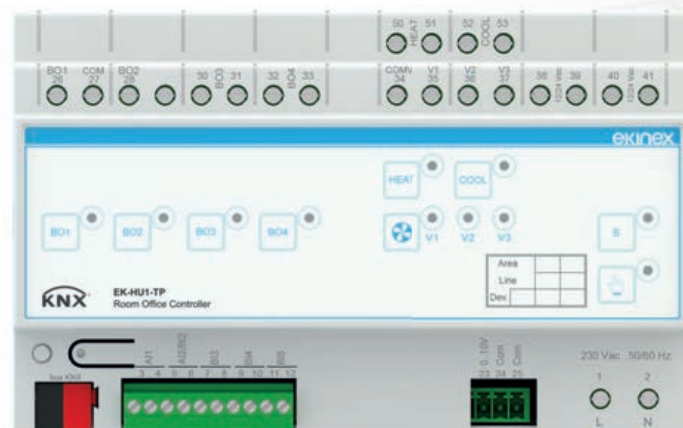

Description

The EK-HU1-TP module represents an extremely versatile and compact solution that integrates in a single device all the functions required to control various types of room: lighting, climate control, shading, control of electrical loads and input and output signals.

The module is mounted on a standard 35 mm rail according to EN 60715; thanks to its very small dimensions (8 modular units, 144 mm wide), also in consideration of the many functions performed, the module helps to save space in switchboards and electrical distribution cabinets. In case of need, the front keypad allows manual operation.

Technical data

Input	Nr.	Use
Analogic	2	for NTC temperature sensors
Digital (generic)	5	to be used individually or coupled

Output	Nr.	Use
Digital	4	to be used individually for ON/OFF switching of loads or coupled for roller shutters or venetian blinds, 5(3) A relay
	1	for control of 1 electric lock (12/24 Vac powered), 5(3) A relay
	5	dedicated to fan-coil unit control: - 3 for 3-speed fan, 5(3) A relay - 2 for ON / OFF control of valves, 16(10) A relay
Analogic	1	for 0-10 V control of fan (with brushless motor) speed

Order information

Code	Package
EK-HU1-TP	1 pcs.

 **Configuration and commissioning**
By means of ETS4 2.0 software (or later versions)
Application program: **APEKHU1TP##.knxprod**
(## = version, downloadable from www.ekinex.com)

 **Documentation**
For more information see the technical documentation,
download from www.ekinex.com



HEATING AND COOLING

Use as KNX actuator for fan-coil units in combination with an Ekinex room thermostat.

Use as KNX actuator-controller (integrated controller) for fan-coil units in combination with

- KNX sensors (temperature value received via bus) or
- NTC temperature sensors (temperature value acquired through a specific input configuration).

Main functions

- 3-speed or 0-10V fan control with brushless motor and inverter board
- ON/OFF control of one valve or two valves respectively for 2 or 4 pipe distribution
- Local or centralised heating / cooling switching
- Automatic heating/cooling attenuation at window opening
- Starting the fan according to the actual water temperature (hot-start / cold-start)
- Fan activation in case of air stratification (large volume rooms)
- Condensation level monitoring
- Hours of operation monitoring with filter replacement signaling



DOOR LOCK CONTROL

Output for sending impulses to an electrical lock for use in combination with:

- an Ekinex card reader or
- a traditional (non-bus) card reader with signalling contact connected to an input configured for this purpose;
- other KNX devices (by receiving a communication object on the bus).



SHADING

Use as KNX actuator for controlling and monitoring of motorized drives for shading devices (roller shutters, venetian blinds or curtains) or motorized doors / windows in combination with:

- Ekinex KNX pushbuttons or
- traditional (non-bus) pushbuttons of standard market series by means of special configuration of the inputs.

Main functions

- Complete run (up and down or open and close)
- Partial run (stop in position from 0 to 100%)
- Position setting
- Slat inclination adjustment (venetian blinds)
- Integration in scenarios
- Lock, forced operation
- Status indication



LIGHTING AND OTHER ELECTRICAL LOADS

Use as KNX actuator for ON / OFF switching of luminaires or other electrical loads in combination with:

- Ekinex KNX pushbuttons or
- traditional (non-bus) pushbuttons of standard market series by means of special configuration of the inputs.

Input/output module for hotel applications

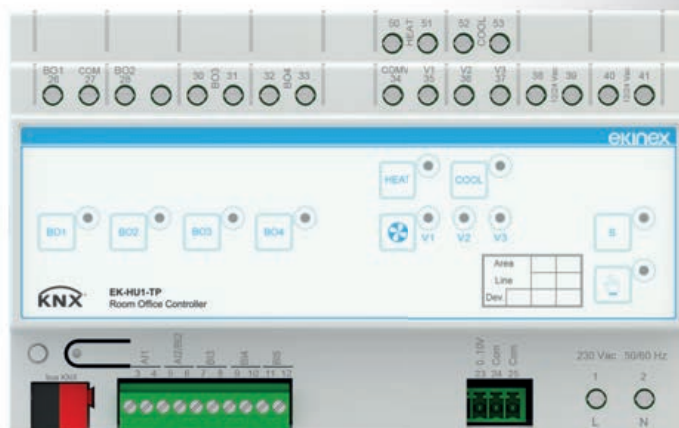

Description

The EK-HU1-TP module represents an extremely versatile and compact solution that integrates in a single device all the functions required to control various types of room: lighting, climate control, shading, control of electrical loads and input and output signals.

The module is mounted on a standard 35 mm rail according to EN 60715; thanks to its very small dimensions (8 modular units, 144 mm wide), also in consideration of the many functions performed, the module helps to save space in switchboards and electrical distribution cabinets. In case of need, the front keypad allows manual operation.

Technical data

Input	Nr.	Use
Analogic	2	for NTC temperature sensors
Digital (generic)	5	to be used individually or coupled

Output	Nr.	Use
Digital	4	to be used individually for ON/OFF switching of loads or coupled for roller shutters or venetian blinds, 5(3) A relay
	1	for control of 1 electric lock (12/24 Vac powered), 5(3) A relay
	5	dedicated to fan-coil unit control: - 3 for 3-speed fan, 5(3) A relay - 2 for ON / OFF control of valves, 16(10) A relay
Analogic	1	for 0-10 V control of fan (with brushless motor) speed

Order information

Code	Package
EK-HU1-TP	1 pcs.

Configuration and commissioning

By means of ETS4 2.0 software (or later versions)
Application program: **APEKHU1TP##.knxprod**
(## = version, downloadable from www.ekinex.com)



Documentation

For more information see the technical documentation, download from www.ekinex.com



SHADING

Use as KNX actuator for controlling and monitoring of motorized drives for shading devices (roller shutters, venetian blinds or curtains) or motorized doors / windows in combination with:

- Ekinex KNX pushbuttons or
- traditional (non-bus) pushbuttons of standard market series by means of special configuration of the inputs.

Main functions

- Complete run (up and down or open and close)
- Partial run (stop in position from 0 to 100%)
- Position setting
- Slat inclination adjustment (venetian blinds)
- Integration in scenarios
- Lock, forced operation
- Status indication



LIGHTING AND OTHER ELECTRICAL LOADS

Use as KNX actuator for ON / OFF switching of luminaires or other electrical loads in combination with:

- Ekinex KNX pushbuttons or
- traditional (non-bus) pushbuttons of standard market series by means of special configuration of the inputs.



HEATING AND COOLING

Use as KNX actuator for fan-coil units in combination with an Ekinex room thermostat.
Use as KNX actuator-controller (integrated controller) for fan-coil units in combination with:

- KNX sensors (temperature value received via bus) or
- NTC temperature sensors (temperature value acquired through a specific input configuration).

Main functions

- 3-speed or 0-10V fan control with brushless motor and inverter board
- ON/OFF control of one valve or two valves respectively for 2 or 4 pipe distribution
- Local or centralised heating / cooling switching
- Automatic heating/cooling attenuation at window opening
- Starting the fan according to the actual water temperature (hot-start / cold-start)
- Fan activation in case of air stratification (large volume rooms)
- Condensation level monitoring
- Hours of operation monitoring with filter replacement signaling



DOOR LOCK CONTROL

Output for sending impulses to an electrical lock for use in combination with:

- an Ekinex card reader or
- a traditional (non-bus) card reader with signalling contact connected to an input configured for this purpose;
- other KNX devices (by receiving a communication object on the bus)

Examples of switching and controlling points



Bed header

The double combination controls the bed-head and central light and opens / closes the motorized curtains. You can inform outside the room and at the reception not to disturb or make a call to the staff. The sound system is activated or everything can be switched off when it's time to sleep. The sockets allow you to supply 230 Vac or 5 Vdc (via USB connector) loads.



Entrance

As you enter the room, the pushbutton controls the entrance light, the bathroom light and the main light. It is also possible to inform the outside of the room and the reception not to disturb.



Central position

The double combination controls the main light, the hallway light and the free-standing light, and opens and closes the motorized curtains. Scenarios are recalled. The room thermostat allows complete control of heating, cooling and ventilation. It offers the guest the possibility to change the desired value. temperature; in addition to automatic operation, the ventilation speed can be set manually or switched off.



Balcony exit

At the exit to the room balcony, the pushbutton controls the main and external light, and allows to raise / lower the shutter.

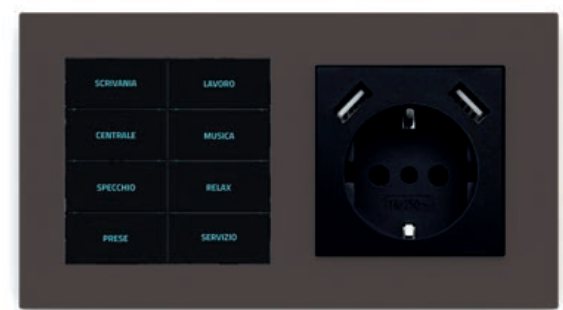

Desk

At the desk you can control several luminaires, activate the sound system or call the staff, if necessary. With a single gesture, you call up scenarios. The sockets allow you to supply 230 Vac or 5 Vdc (via USB connector) loads.

Material and finishes

* ON REQUEST
The range finishes shown on the left are the result of a company stylistic choice. Additional finishes in Fenix NTM® and metal are also available upon request (non-standard processes may be subject to limitation).

METAL HT

CRO Chrome	GBM Black Metal	COP Copper coming soon	CHA Champagne coming soon
Plates 20venti FF 71	Plates 20venti FF 71	Plates 20venti FF 71	Plates 20venti FF 71
Rockers FF 71	Rockers FF 71	Rockers FF 71	Rockers FF 71

METAL (BRUSHED)

GBQ Aluminium Brushed finishing	GBR Nickel Brushed finishing	GBS Titanium Brushed finishing	GBU Carbon Brushed finishing	GBB Brass Brushed finishing
Frames FF-71 Form FF-71 Flank	Frames FF-71 Form FF-71 Flank	Frames FF-71 Form FF-71 Flank	Frames FF-71 Form FF-71 Flank	Frames FF-71 Form FF-71 Flank
Plates 20venti FF 71	Plates 20venti FF 71	Plates 20venti FF 71	Plates 20venti Deep FF 71	Plates 20venti FF 71
Rockers FF 71	Rockers FF 71	Rockers FF 71	Rockers FF 71	Rockers FF 71

PLASTIC

GAA White	GAE Intense black RAL 9005	GAG Silver metallic plastic
Frames FF-71 Form FF-71 Flank	Frames FF-71 Form FF-71 Flank	Frames FF-71 Form FF-71 Flank
Plates 20venti Deep FF 'NF and Deep 71 'NF and Deep	Plates 20venti Deep FF 'NF and Deep 71 'NF and Deep	Plates 20venti Deep FF 'NF and Deep 71 'NF and Deep
Rockers 20venti FF	Rockers 20venti FF	Rockers 20venti FF

PLASTIC ON REQUEST

GAB Ice white* Soft-touch finish	GAC Fire white*	GAD Fire white* Soft-touch finish	GAF Intense black* Soft-touch RAL 9005	GAI Hematite* metallic plastic	GAL Graphite* metallic plastic
Frames FF-71 Form FF-71 Flank	Frames FF-71 Form FF-71 Flank	Frames FF-71 Form FF-71 Flank	Frames FF-71 Form FF-71 Flank	Frames FF-71 Form FF-71 Flank	Frames FF-71 Form FF-71 Flank
Plates 20venti Deep FF 'NF and Deep 71 'NF and Deep	Plates 20venti Deep FF 'NF and Deep 71 'NF and Deep	Plates 20venti Deep FF 'NF and Deep 71 'NF and Deep	Plates 20venti Deep FF 'NF and Deep 71 'NF and Deep	Plates 20venti Deep FF 'NF and Deep 71 'NF and Deep	Plates 20venti Deep FF 'NF and Deep 71 'NF and Deep
Rockers FF 71	Rockers 20venti FF - 71	Rockers FF 71	Rockers FF 71	Rockers 20venti FF - 71	Rockers 20venti FF - 71

FENIX NTM®

FBM White Maïè	FBL Beige Luxor	FCO Beaver Ottawa	FGE Grey Efeso	FGL Grey London	FGB Grey Bromine	FVC Green Commodore	FCC Cocoa Orinoco	FNI Black Ingo
Plates 20venti FF 71	Plates 20venti FF 71	Plates 20venti FF 71	Plates 20venti FF 71	Plates 20venti FF 71	Plates 20venti FF 71	Plates 20venti FF 71	Plates 20venti FF 71	Plates 20venti FF 71
Rockers FF 71	Rockers FF 71	Rockers FF 71	Rockers FF 71	Rockers FF 71	Rockers FF 71	Rockers FF 71	Rockers FF 71	Rockers FF 71

Fenix NTM®

MATERIALS

A super opaque nanotech material, is an innovative interior design product, that combines elegant aesthetic solutions with state-of-the-art technological performance.

The external Surface of Fenix NTM® involves the use of nanotechnology and it is characterized by next generation acrylic resins, hardened and fixed with Electron Beam Curing process opening up new avenues in the field of interior design. With low light reflectivity, its Surface is extremely opaque, anti-fingerprint and features a very pleasant soft touch. Thanks to the use of nano-technologies, Fenix NTM® thermally heals any superficial micro-scratches, as its name indicates. In addition, Fenix NTM® is highly resistant to scratches, abrasion, rubbing and dry heat. It also withstands impacts, acid-based solvents and household reagents. It significantly reduces the bacterial load making its Surface hygienic and easy to clean. It is also liquid repellent and mould-proof. For more information: <https://en.ekinex.com/fenix-ntm.html>



Low light reflectivity



Thermal healing of microscratches



Anti-fingerprint



Soft touch

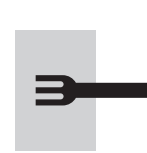

Resistance to scratches and abrasion



Resistance to dry heat



High resistance to acid solvents and household reagents



Enhanced anti-bacterial properties



Hygienic

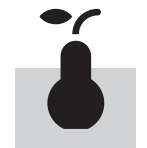

Suitable for contact with food



Easy to clean



Mold-resistant



Antistatic



Hydro-repellent



Dimensional stability even at high temperature changes



Resistance to impact



Lightfastness



Excellent intensity and colour depth



Rub resistance



Self-supporting (only for 10 and 12 mm)

The rockers for the 20venti, FF and 71 series can be customized using the symbols in the library below. On request it is also possible to customise them using symbols and texts indicated by the customer.

Square rockers

Single Symbol

The single symbol is reproduced in the middle area of the square rocker, centered vertically and horizontally.

Double symbol

The double symbol is reproduced in the upper and lower areas of the square rocker, centered horizontally.

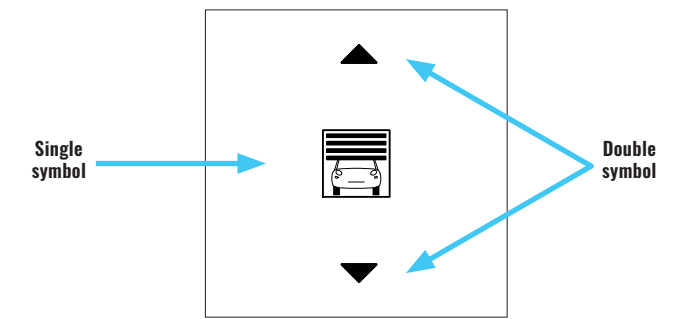

Vertical rectangular rockers

Single Symbol

The single symbol is reproduced in the middle of the rectangular rocker, centered vertically and horizontally.

Double symbol

The double symbol is reproduced in the upper and lower areas of the rectangular rocker, centered horizontally.

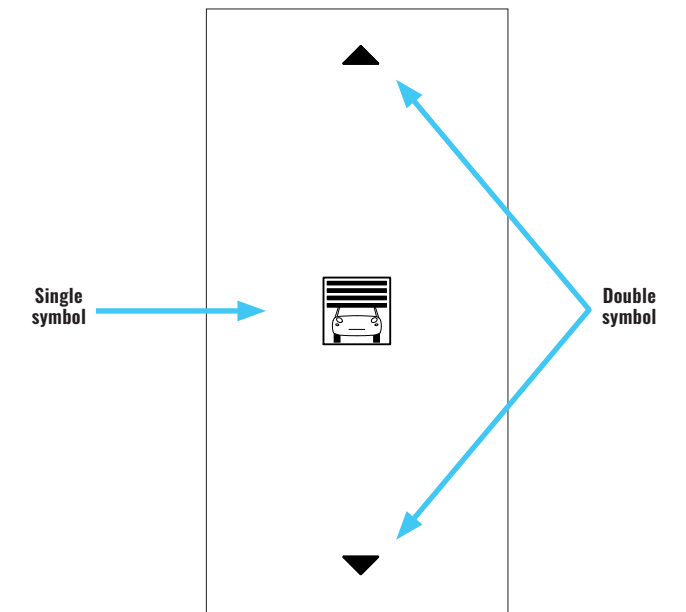

Horizontal rectangular rockers

Single Symbol

The single symbol is reproduced in the central area of the rectangular rocker, centered vertically and horizontally.

Double symbol

The double symbol is reproduced in the side areas (right and left) of the rectangular rocker, centered vertically.

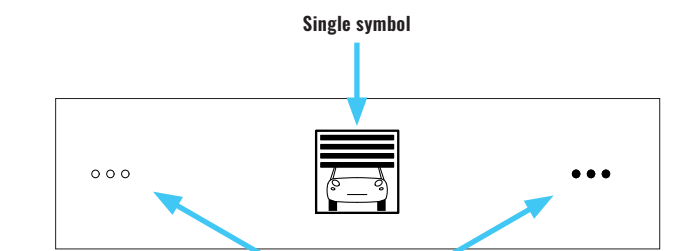

Symbols for rockers customization

PUSHBUTTONS

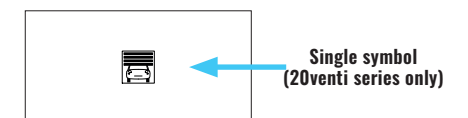

Single symbols



NS00 No symbol

Lighting

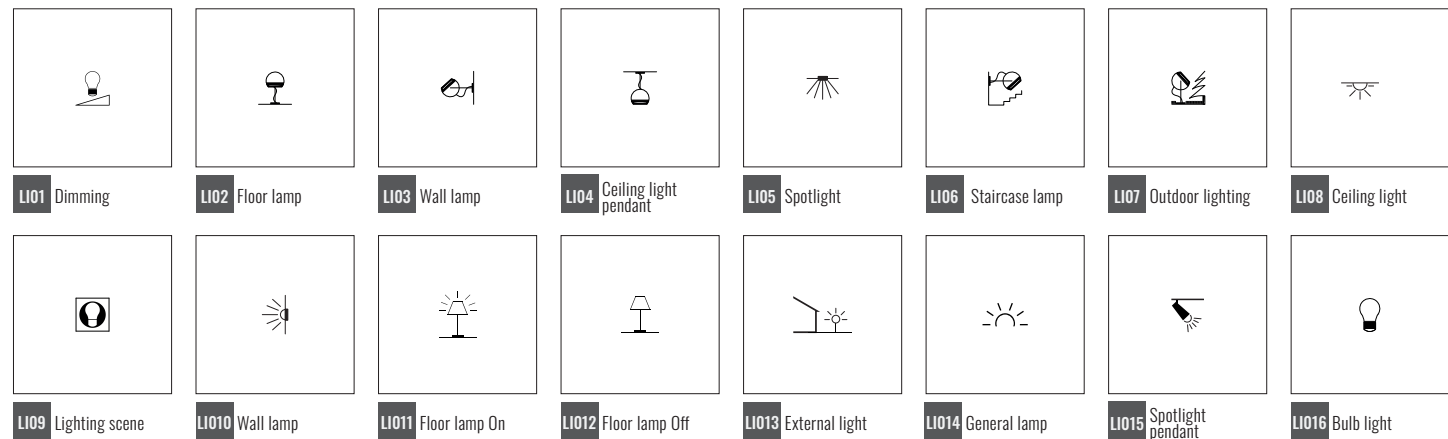

Multimedia

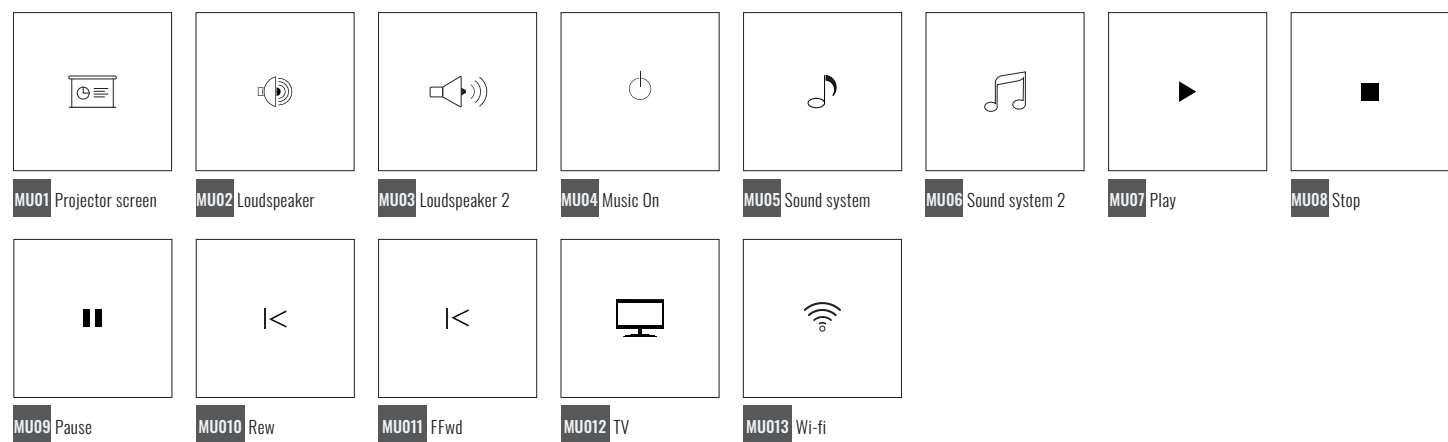

Health and care

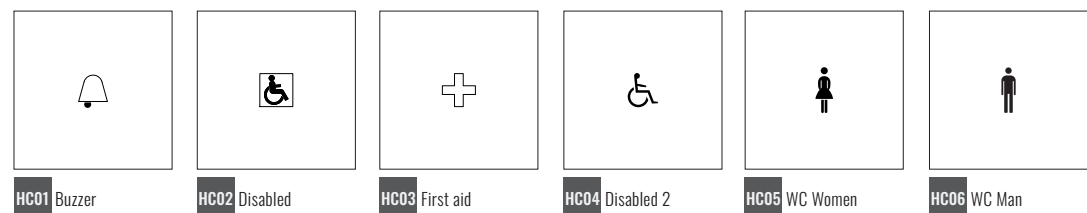

Door and garage

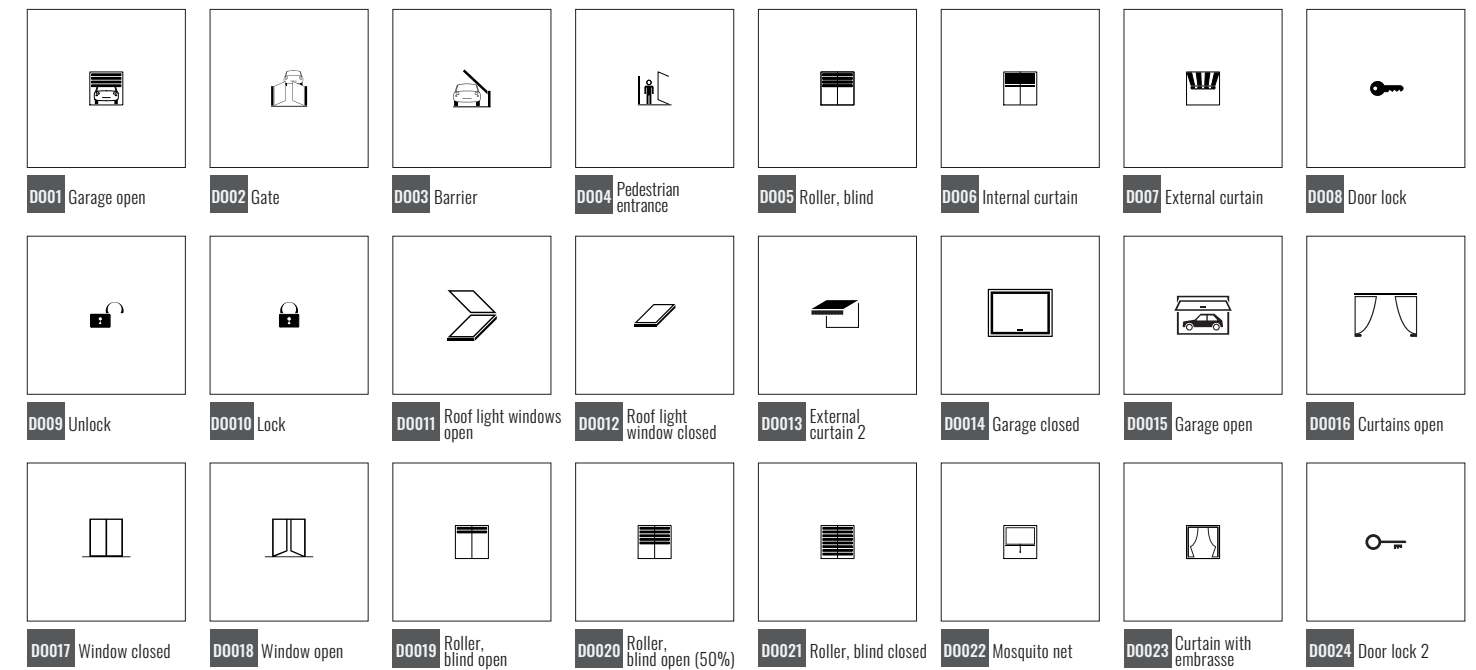

Hotel

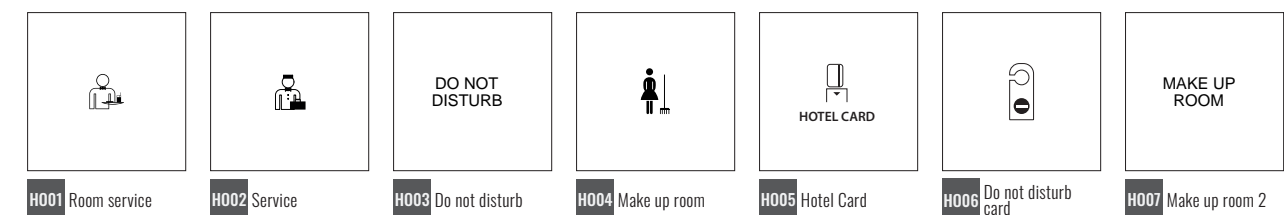

Energy

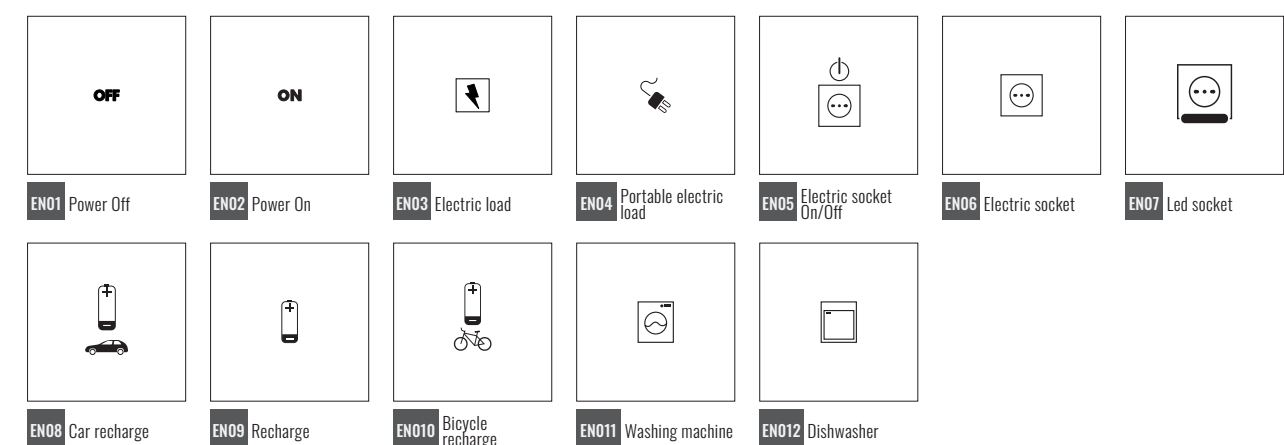

Climate

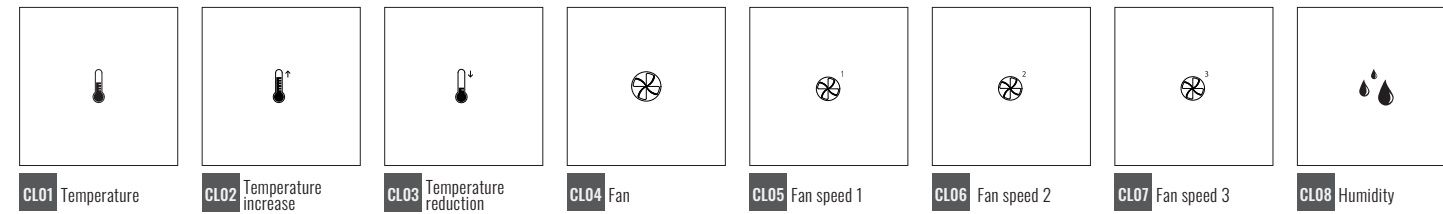

Scene

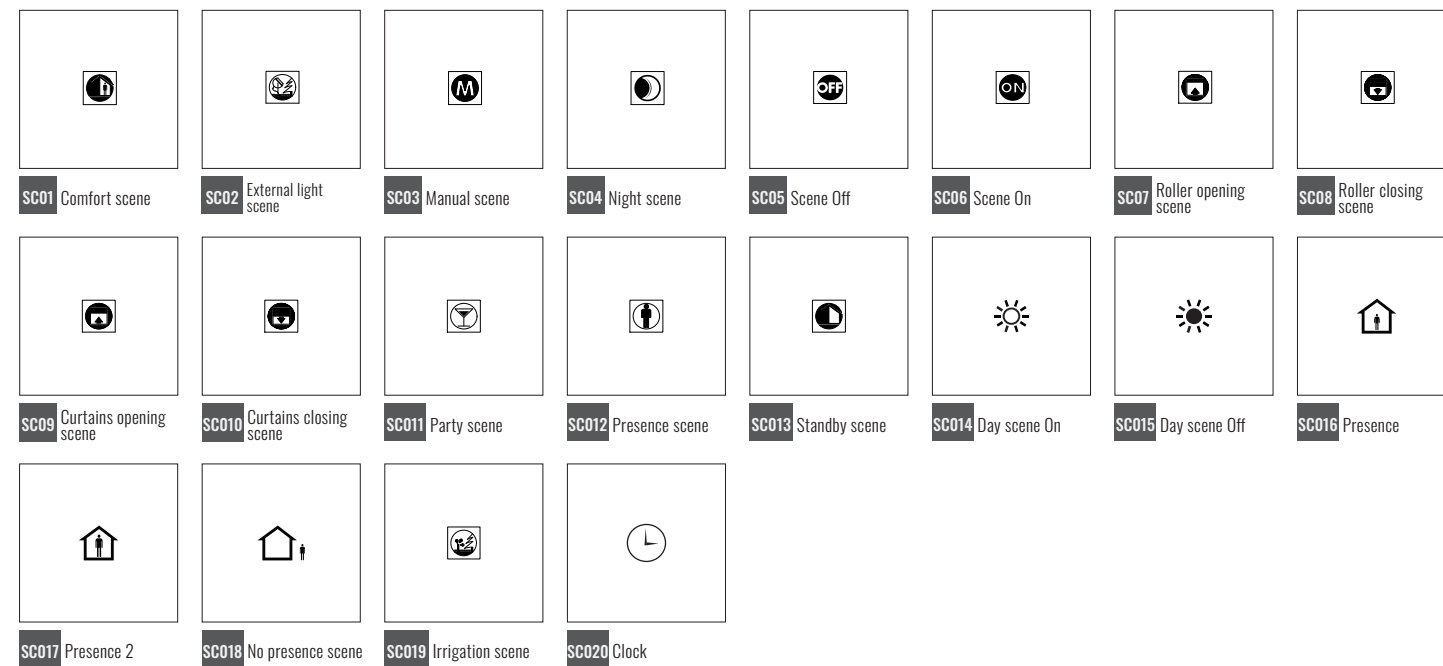

Marker

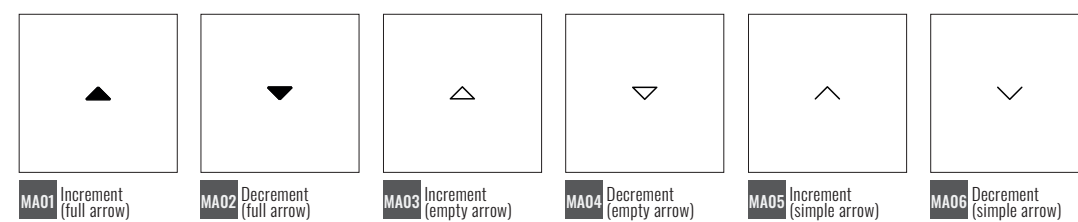

Note. For convenience, all the symbols in this page are shown as they appear on square rockers. The same symbols may also be requested for rectangular rockers.

Note. The symbols shown here can be replaced by customised symbols or text on request.

Double symbols

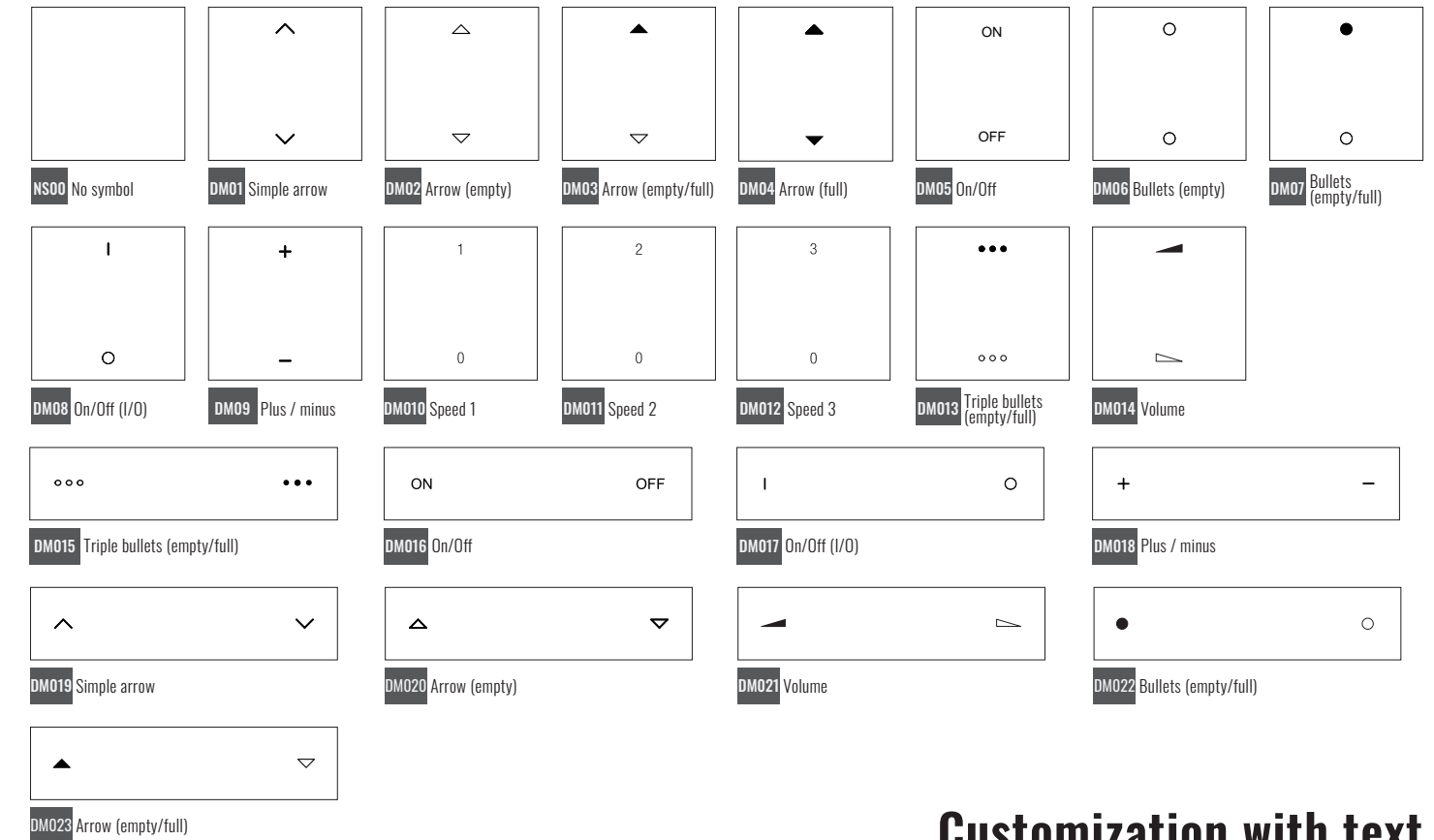

Customization with text

Square rockers can be customized with text to be shown in the upper, central or lower areas. Texts must be specified at order time.

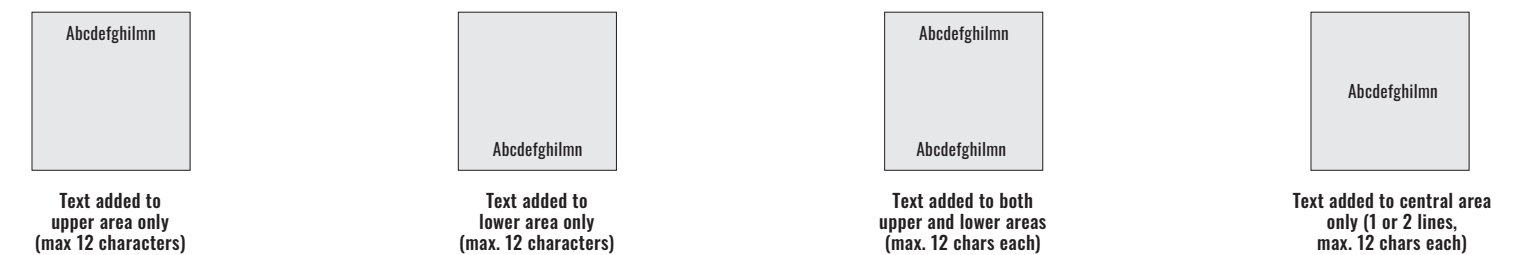

Horizontal rectangular rockers can be customized by means of text in their central area.

Vertical rectangular rockers can be customized with text to be shown in the upper, central or lower areas.

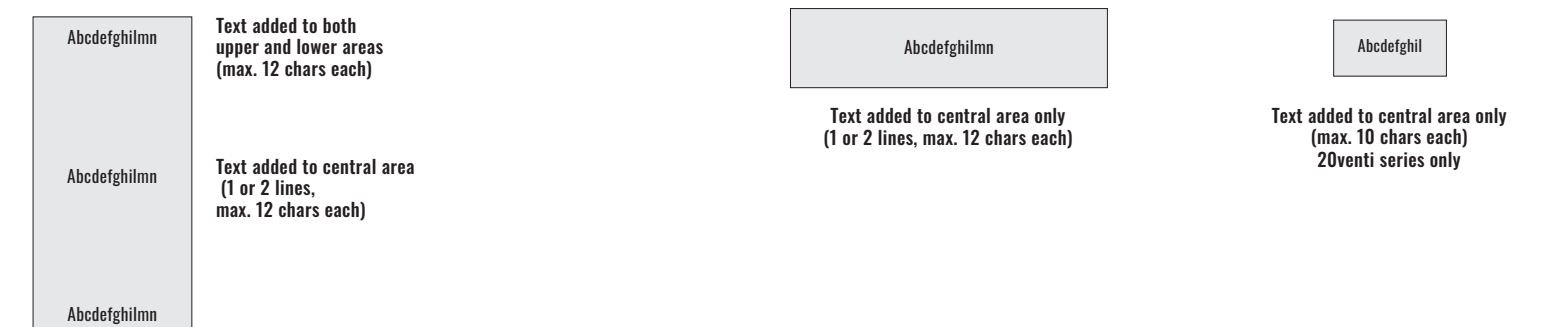

Delégo

SUPERVISION

Delégo is a complete system for the supervision and control of a KNX standard installation. Developed with web-oriented technologies, it has a uniform interface with high graphical impact on every platform with local and remote connection. The system consists of a server to be installed in a switchboard that connects directly to the KNX bus; the connection to the router is made through the Ethernet port on your local network (LAN). Delégo offers multiple possibilities of use:

- via desktop PC;
- from mobile smartphone and tablet devices (Apple iOS and Android);
- with one or more fixed Delégo panel stations.

The system is characterized by a simple and at the same time extremely complete configuration, thanks to the direct import of the ETS project file. The functional definition of the various imported objects and the correspondence with a rich and customizable set of controls (widgets) for the user is also very easy. The interface is simple and intuitive and allows the user to interact with the building automation system through the use of different devices, with absolute uniformity of use. The app allows to control all functions with a simple touch, from a single device and from any point of the building reached by the Wi-Fi network, or remotely via web connection.





Delégo server

SUPERVISION

Description

Web supervisor for home and building automation systems based on the KNX system. It allows to manage the functions present in the building through any type of device (PC/MAC, touch-PC, smartphone, tablet) as long as it is equipped with a web browser, both locally and remotely through internet. Customizable graphics suitable for any context and application, optimized for visualization on different fixed and mobile platforms. Simplified and fast configuration of KNX functions. Possibility to realize scenarios, time sequences, logics, conditions, operations mathematics, temporal planning through simple graphical tools and intuitive; reporting events and alarms on screen or via email. Configuration online or offline via free downloadable PDF tool; does not require programming or HTML skills for supervision customization. Interfacing with other communication technologies and protocols through the installation of additional modules

Main features

- **Dimensions:** 90.5 x 62 x 36 mm 2 DIN modules
- **Power supply** 12 - 24 VDC Plug-in terminal provided
- **Absorption** 240mA at 24V
- **Connections** LAN (RJ45)
KNX (standard red-black connector)
RS485 (terminal supplied)
USB
- **LED** Power
Service / Reset
- **Degree of protection** IP 20 (according to EN 60529)
- **Insulation class** II (according to EN 60335-1)
- **Operating temperature** +0°C ... +40°C
- **Storage temperature** 10°C ... +70°C

Dimensions [mm]

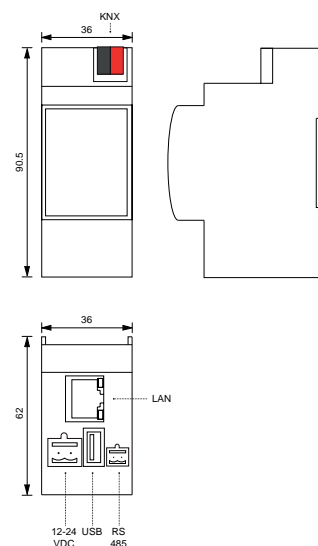

Documentation

For more information see the technical documentation, download from www.ekinex.com



Order information - Licenses

Code	Composition	License version	KNX Addresses	Scenarios	Logics/Thresholds	Environments	Loads	Cameras
EK-DEL-SRV-BAS-TP	Delégo server	BASIC	400	100	100	Unlimited	Unlimited	Unlimited
EK-DEL-UPGR-BA	Upgrade License	ADVANCED	1200	100	100	Unlimited	Unlimited	Unlimited
EK-DEL-UPGR-BP		PREMIUM	2500	100	100	Unlimited	Unlimited	Unlimited
EK-DEL-V1	Voucher	Integration with: multimedia, video surveillance, IP video intercom, intrusion detection, Modbus RS485/TCP-IP (> 30 registers), energy module						

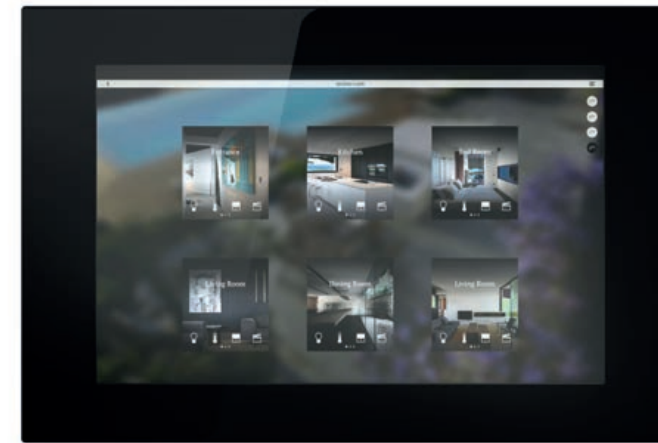
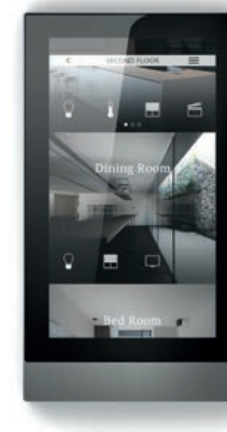

Delégo panel

SUPERVISION

Description

Delégo panel allows the control of all building automation functions. It is available in two versions with a 5" and 8" capacitive display and is completed by a frame in glossy black .

Main features

- **Overall dimensions (mm)** 81 x 132 x 14 (5") - 224 x 149 x 16 (8")
- **Typology** LCD HD IPS 5" - LCD HD IPS 8"
- **Resolution** 1280 x 720
- **Colours** 16.7 million colours (true colour)
- **Brightness** 400 nits
- **Touch screen** Capacitive with multi-touch & gestures support
- **Speakers** High definition with built-in 2W amplifier
- **Microphone** Integrated high resolution with echo canceling
- **Gyroscope** Automatic orientation detection
- **Proximity** Integrated proximity detection
- **Brightness** Integrated ambient light sensor
- **Connectivity** LAN 100baseT
- **Certifications** CE / FCC class B / FCC part15 / ROHS / WEEE
- **Operating System** Android 6

Possibility of customization through aluminium frame (5" version only)

Dimensions [mm]

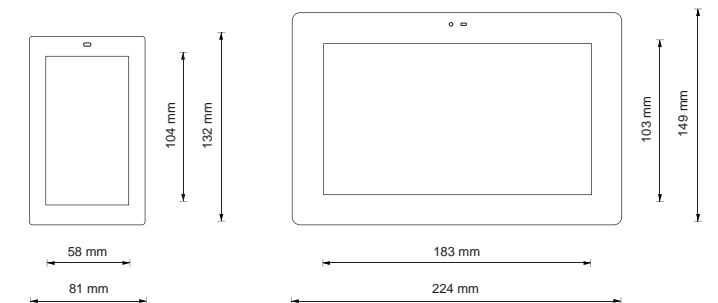

Order information

Code	Composition
EK-DEL-5PAN	Delégo panel 5" - black panel
EK-DEL-8PAN	Delégo panel 8" - black panel
EK-DEL-5FR-...	Aluminium frame for 5" Delégo panel

(*) The three-seat flush-mounted box (hole spacing: 83.5 mm) must be mounted with the same orientation as the device



Documentation

For more information see the technical documentation, download from www.ekinex.com



APPLICATION EXAMPLES

Application examples	
Access control and presence detection	44
Lighting	45
Heating and cooling with fan-coils	48
Heating and cooling with radiant systems	50
Ventilation and air renewal	52
Supervision	54
Shading and other drives	56
Voice control	57
Monitoring of technological systems	58
Consumption monitoring	59
Further information	
Energy efficiency	62
neZEH - nearly Zero Energy Hotel	62
Indoor Environmental Quality (IEQ)	63
Certified sustainability	63

Access control and presence detection



The Ekinex system for access control and presence detection is based on transponder technology, which makes full use of its flexibility and security features. The devices **(D, E, H)**, fully compatible with the KNX system, can be combined with the Ekinex pushbuttons series for wall mounting. The EK-TSW Accédo **(F)** PC supervision and programming software for PC completes the system offer and can also be the interface to other communication protocols commonly used in the HVAC sector such as BACnet, Modbus or M-Bus.

Card programming

The programming of the cards and the configuration of the devices can be performed from the reception desk or from another location where the card programmer **(H)** is installed, connected via KNX/IP interface or router **(G)**, to a PC with Accédo software **(F)** installed.

Application example

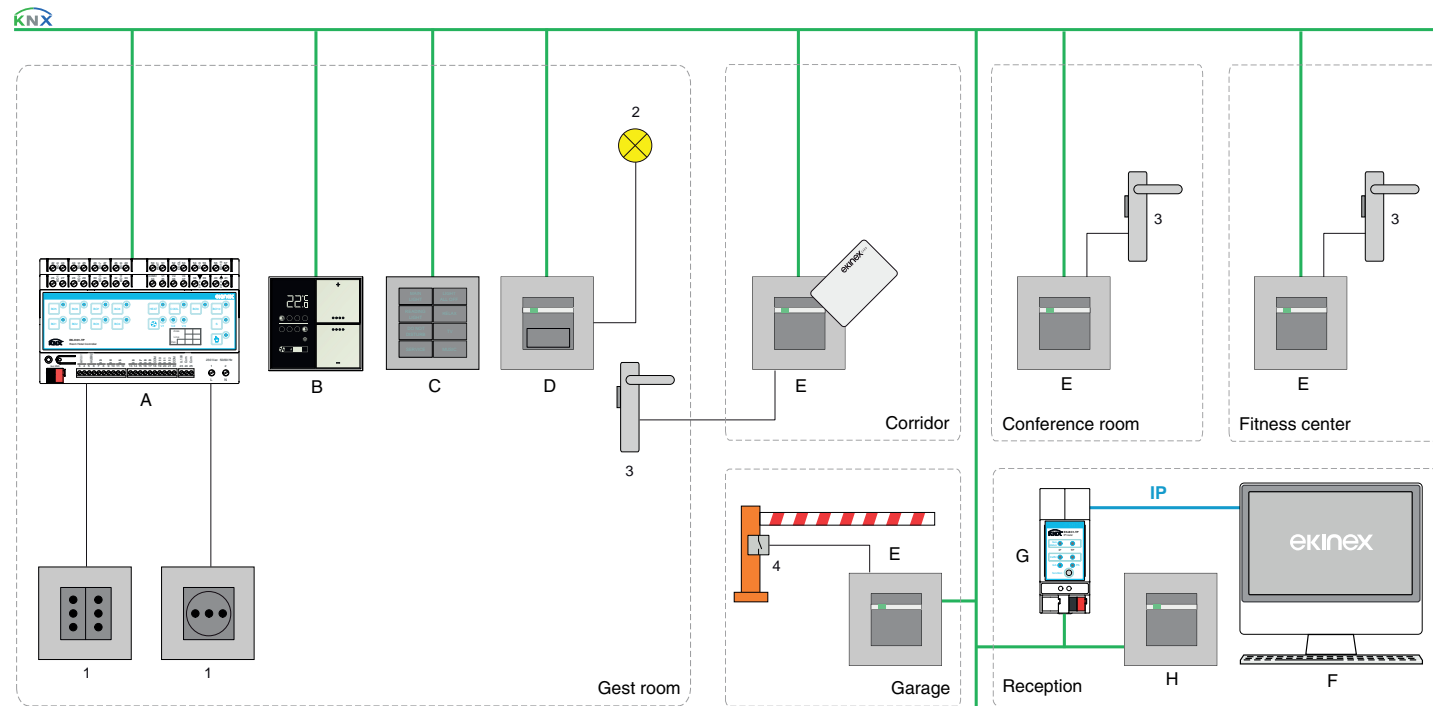

Ekinex devices

- A) Hotel module EK-H01-TP
- B) Room temperature controller EK-EQ2-TP
- C) Ekinex pushbutton (20venti series)
- D) Card holder EK-TH2-TP
- E) Card reader EK-TR2-TP
- F) Accédo software EK-TSW
- G) KNX/IP router EK-BC1-TP
- H) Card programmer EK-TP2-TP

Other components

- 1) Sockets for loads to be controlled
- 2) Courtesy light (room entrance)
- 3) Electric door lock
- 4) Garage barrier opening contact

Lighting

Lighting plays a very important role in accommodation facilities; whether it is for business trips, conferences, family holidays or other occasions, staying in a hotel should be a special experience and lighting is crucial for spending good time indoors.

In the case of facilities housed in buildings of historical and architectural value, the external lighting also plays an important role: especially in the evening and at night it enhances the most important elements of the building, creating an exclusive and engaging atmosphere. In all these situations it is the lighting design that determines the fundamental choices, such as the shape and size of the luminaires, the light sources, the colour temperature, the distribution between direct and indirect components and between basic and accent lighting and much more. Without a flexible and high-performance control system, however, the result may not be satisfactory. The versatility of Ekinex, together with the greater possibilities offered by LED sources, allows to manage the lighting in a truly intelligent way and to create tailor-made solutions to meet the complex and differentiated needs of an accommodation facility, typically composed of indoor spaces that differ in size and use. Automatic control, scene recall, exploitation of natural light, dynamic light: a system like Ekinex allows to always have the most correct light in the right place, at the right time and with the right intensity.

The luminaires can be controlled directly with Ekinex pushbuttons, sensors, outputs and actuator-dimmers, if necessary also interfacing with a DALI system via the KNX / DALI gateway.

Control with Ekinex

In the corridor, the basic lighting **(5)** is constantly on in the absence of sufficient natural light to ensure that guests are not in the dark when leaving their rooms. The main lighting **(6)** is switched on automatically only when the EK-DF2-TP sensor **(G)** detects people moving; it is switched off with a delay that can be set.

When the EK-TR2-TP card reader **(F)** enables access to the room, the courtesy light **(7)** at the entrance is automatically switched on. The following insertion of the card into the EK-TH2-TP card holder **(E)** can activate one or more luminaires.

The EK-H01-TP hotel module **(A)** has relay outputs for the ON/OFF switching of luminaires or sockets **(1)** to which mobile luminaires, such as a free-standing luminaire, are connected. All luminaires can also be controlled manually by one or more pushbuttons **(D)**. If there are luminaires with dimmable sources, the EK-GA1-TP universal dimmer **(B)** or the EK-GC1-TP RGBW LED dimmer **(C)** can be used depending on the light source.

Application example

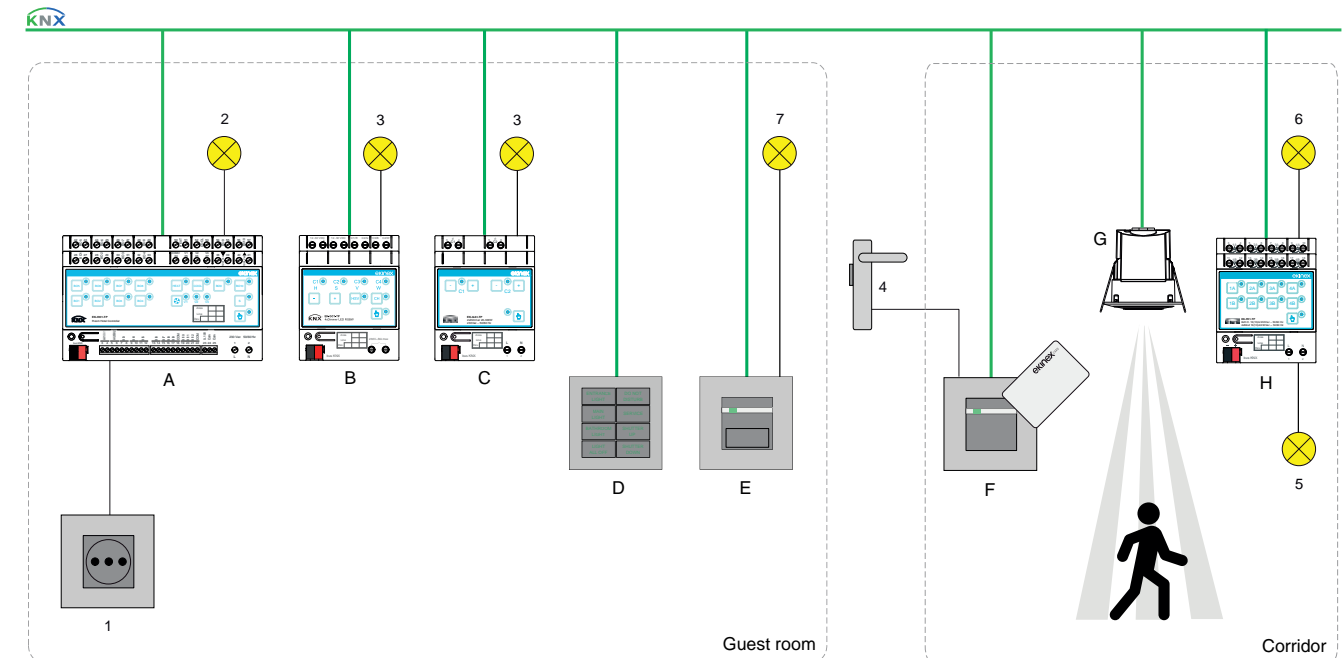

Ekinex devices

- A) Hotel module EK-H01-TP
- B) Dimmer LED RGBW EK-GC1-TP
- C) Universal dimmer EK-GA1-TP
- D) Ekinex pushbutton (20venti series)
- E) Card holder EK-TH2-TP
- F) Card reader EK-TR2-TP
- G) Presence sensor EK-DF2-TP
- H) Binary output EK-FE1-TP

Other components

- 1) Controlled socket for mobile luminaires
- 2) Non-dimmable luminaires
- 3) Dimmable luminaires
- 4) Electric door lock
- 5) Basic lighting
- 6) Main lighting
- 7) Courtesy light (room entrance)

Control of DALI luminaires with Ekinex

If the luminaires are equipped with DALI communication interfaces at the factory, the lighting can be controlled with Ekinex devices - even those already provided for other building automation functions - using one or more KNX-DALI EK-BG1-TP (E) gateways.

Access to the room via the EK-TR2-TP card reader (A) can automatically switch on the courtesy light at the entrance. Inserting the card into the EK-TH2-TP card reader (B) can automatically switch on the main light. The light intensity of a luminaire or a group of luminaires can be manually switched on, off or adjusted using the push-button (C). For passageways, the EK-DF2-TP presence sensor (D) can be used to automatically switch the light on and off.

The DALI standard

DALI* (Digital Addressable Lighting Interface) is a standard protocol, included in the EN 62386 standard series, dedicated to the digital control of lighting functions through bidirectional communication between devices equipped with DALI interface: the transmission medium consists of a 2-wire bus cable able to transmit data and power some types of devices.

To each device can be assigned a unique address, allowing digital control of single devices: the broadcast option is also available in DALI and, similarly to KNX, devices can be programmed to operate in groups. The digital nature of DALI allows each device to report a fault, answer a status query or transmit other information. In addition to the first version, the DALI-2 standard has been added to improve interoperability between devices from different manufacturers and define a product certification scheme.

*) DALI, DALI-2 and DiiA, DALI, DALI-2 logos, DiiA and D4i are trademarks of exclusive use of the Digital Illumination Interface Alliance in several countries. Further information: www.digitalilluminationinterface.org



The KNX-DALI gateway EK-BG1-TP is used for bidirectional data connection between a DALI system and a KNX system. The gateway makes it possible to control luminaires equipped with a standard DALI interface via Ekinex KNX devices.

Main features and functions

- Control of max 64 DALI devices in up to 16 groups and 16 scenarios
- Broadcast function
- Individual, group or centralised addressing
- Suitable for operation in emergency lighting systems
- Creation of lighting scenarios
- Possibility of reading the status of the DALI device via KNX
- DALI bus power supply
- Programming via configurator

Application example

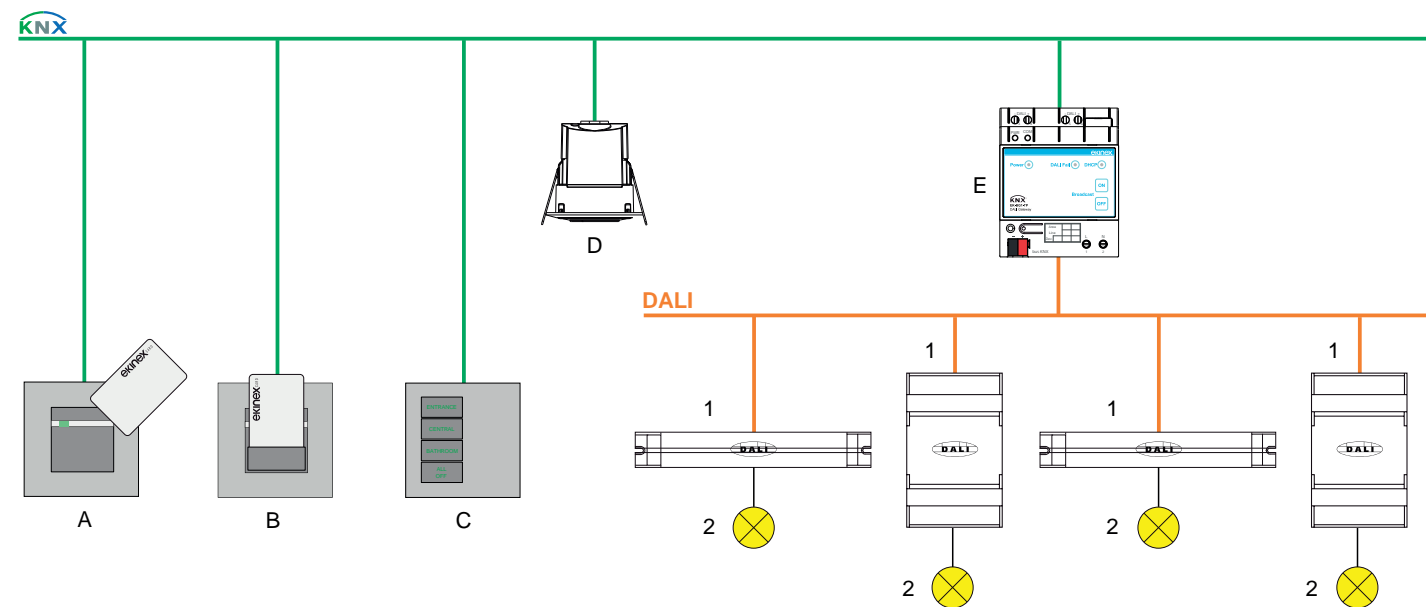

Ekinex devices

- A) Card reader EK-TR2-TP
- B) Card holder EK-TH2-TP
- C) Ekinex pushbutton (20venti series)
- D) Presence sensor EK-DF2-TP
- E) KNX-DALI gateway EK-BG1-TP

Other components

- 1) DALI control gear
- 2) Luminaire / lighting source

In passageways and underground car parks, proper lighting is essential to make the rooms absolutely safe for the guests of the hotel, especially for those who are staying there for the first time. Light helps people to walk around the spaces easily and makes it easier to identify moving vehicles, parked vehicles, obstacles and potential dangers. The automatic switching with presence sensor is the ideal solution in such cases: it avoids the hassle of searching for the switching point and makes it easier for people with their luggage to move around.

Control with Ekinex

In passageways, the basic lighting, consisting of marker lamps (2), is switched on continuously when daylight falls below a threshold value; if the EK-DF2-TP sensor (A) detects the movement of people, the main lighting is also switched on. All luminaires, individual or group luminaires, are switched ON/OFF via the EK-FE1-TP binary output (B). The main lighting is switched off with a delay (that can be set) when no more movement is detected.

In the garage, close to the elevator landing or stairways, it is advisable to use the EK-DH4-TP presence sensor (C), which offers a higher degree of protection (IP54 for ceiling mounting, IP55 for wall mounting).

At the vehicle entrance, the main lighting can instead be activated by the same EK-TR2-TP card reader (D) which enables access to the vehicle at the barrier after the card has been validated.



Presence sensors



Application example

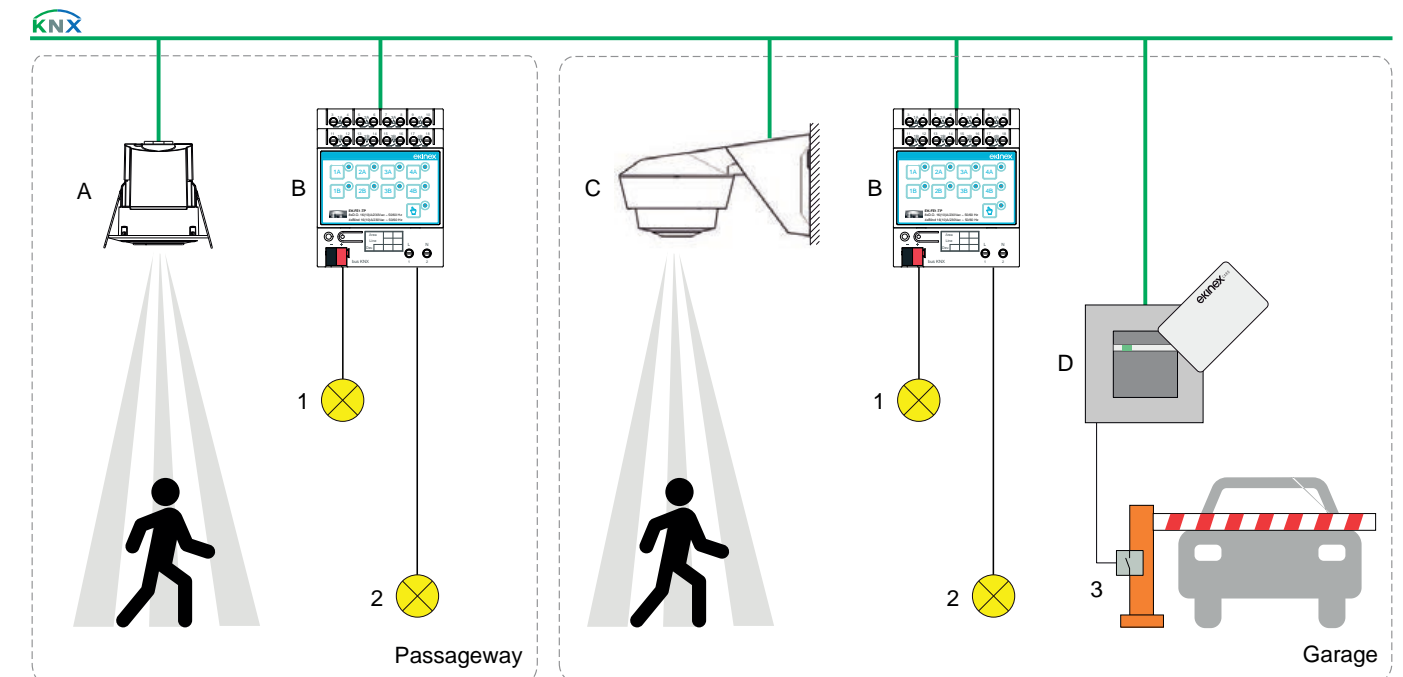

Ekinex devices

- A) Presence sensor EK-DF2-TP
- B) Binary output EK-FE1-TP
- C) Presence sensor EK-DH4-TP
- D) Card reader EK-TR2-TP

Other components

- 1) Luminaire for ceiling installation (main lighting)
- 2) Marker lamps (basic lighting)
- 3) Garage barrier opening contact

Heating and cooling with fan-coils



Fan-coils are terminal units for room heating, cooling and ventilation that are widely used in hotel buildings and, in general, in accommodation facilities such as guest houses, residences, bed & breakfast and farm holidays.

Control with Ekinex

The application examples show two widely used system configurations. In the first example, the fan-coil units (1) are connected to a 2-pipe distribution system and in the only exchange coil (3) circulates alternately warm or cold fluid. The temperature of each room is controlled by an EK-EP2-TP room thermostat (A) to which a window opening contact (6) is connected. The EK-HO1-TP hotel module (B) controls the 3-speed fan and the flow of heated or chilled water by means of the valve (2) with ON/OFF servomotor. Connected to the hotel module (D) are a contact of the condensate drip tray (5), an EK-STC-10K-3435 contact temperature sensor (D) and an EK-STI-10K-3435 immersion temperature sensor (C) installed on the flow pipe of the heat transfer fluid. The room thermostat (A) allows the guest to manually change the desired temperature and ventilation operation. If necessary, it is also possible to limit the temperature change range to $\pm 3^{\circ}\text{C}$. Thanks to the bus connection, it is possible to switch the operating mode (e.g. from standby to comfort) from reception when the guest arrives (check-in) or earlier. In this application the switchover between heating and cooling can take place automatically, by measuring the temperature of the conveying fluid coming from the boiler room by means of the immersion temperature probe (C) connected to a hotel module input (B). Alternatively, Ekinex devices can receive the switching from the bus (centralised manual switching).

In the second example, the fan-coil units (1) are connected to a 4-pipe distribution system. With this type of distribution, if both fluids are available from the boiler room, there can be heated and cooled rooms in the same building at the same time according to guests' preferences or exposure. In the same room, it is also possible to heat in the early morning and evening and cool during the central hours of the day. The fan-coil units are equipped with two heat exchange batteries (3, 5) and a fan unit with brushless motor controlled by an inverter board. The room temperature is controlled by the EK-EQ2-TP room thermostat (A). The EK-HO1-TP hotel module (B) has the 0-10V voltage output required to continuously control the fan speed; it also controls the two valves with ON / OFF servomotor (2, 4) for the flow of heated or chilled water. This configuration allows to obtain all the advantages of these terminals: more precise response to the variation of thermal loads, greater temperature stability, reduced noise and high efficiency even at partial load with consequent reduction of electrical consumption.

Comfort and energy saving

In both cases utility functions for comfort, energy efficiency and maintenance of the system can be added according to the needs of managers and guests of the facility.

Temperature reductions can be called up automatically when guests leave the room, simply by removing the card from the EK-TH2-TP card holder (not shown in the picture) which is part of the access control system; in other cases, the opening of a window, detected by the contact (7) connected to an input of the room thermostat (A), automatically switches the operating mode from comfort to building protection, avoiding dissipating heating and cooling energy outside the building.

In the room example, the contact temperature sensor (D) on the heat exchanger allows the fan (4) to be started only when the temperature of the conveying fluid is comfortable for the guests (warm-start function). If the sensor is missing, the function can also be carried out by setting a simple start-up delay.

If the fan-coil units are also used in high or voluminous rooms (such as the lobby, restaurant or conference rooms) air stratification can occur, with energy waste and discomfort for the occupants. To limit this effect, an additional temperature sensor is connected to the room thermostat (A) and a maximum vertical temperature gradient is set not to be exceeded.

The hotel module (B) has an operating hours counter that increases the count when the fan (4) is at least in first speed. When the set time interval is reached, a signal is activated for the replacement of the air filter, facilitating maintenance work.

Application example (2-pipe distribution system)

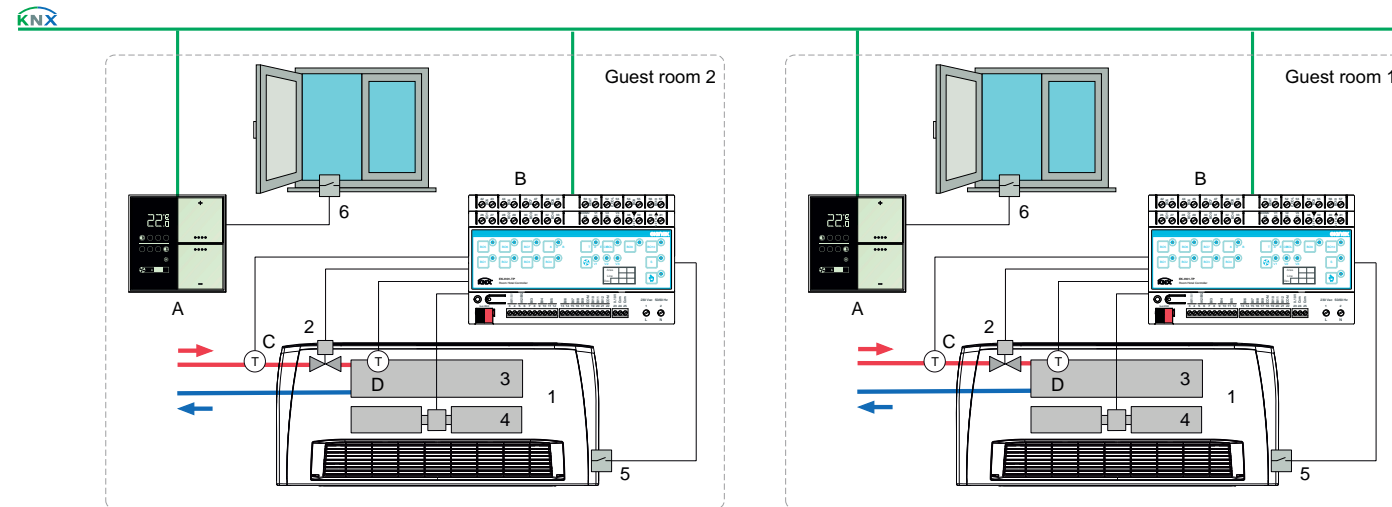

Ekinex devices

- A) Room temperature controller EK-EP2-TP
- B) Hotel module EK-HO1-TP
- C) NTC temperature sensor (immersion) EK-STI-10K-3435
- D) NTC temperature sensor (contact) EK-STC-10K-3435

Other components

- 1) Fan-coil unit
- 2) Valve with ON / OFF servomotor
- 3) Heat exchange battery
- 4) Fan group
- 5) Contact for condensate drip tray
- 6) Window contact

Application example (4-pipe distribution system)

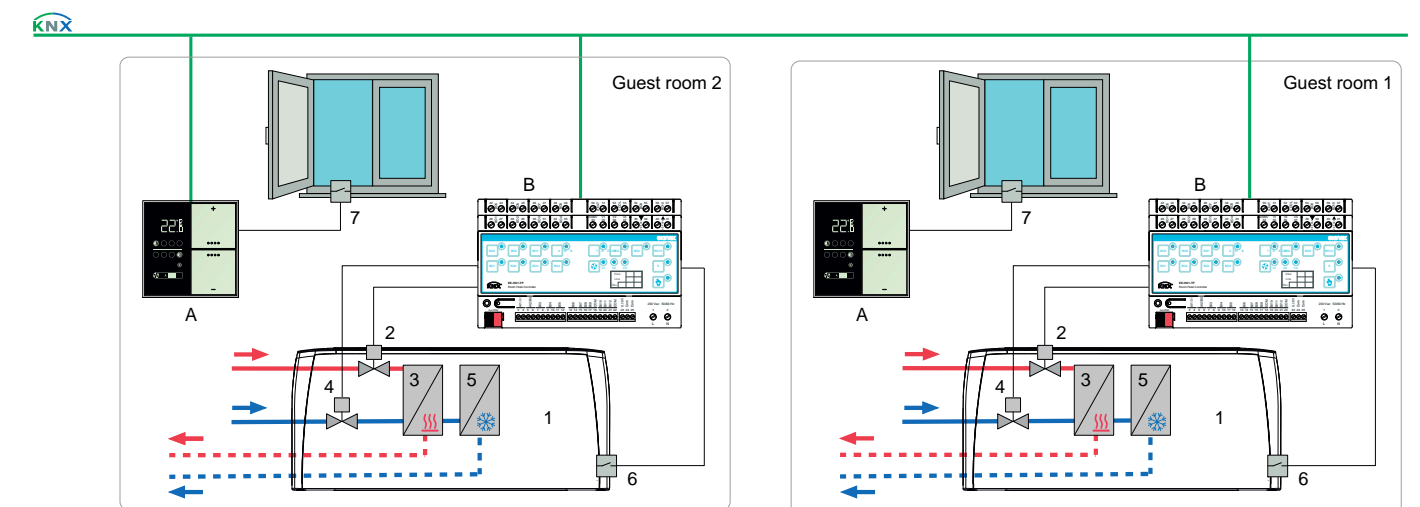

Ekinex devices

- A) Room thermostat EK-EQ2-TP
- B) Hotel module EK-HO1-TP

Other components

- 1) Fan-coil unit
- 2) Valve with ON / OFF servomotor (warm fluid)
- 3) Heat exchange battery (warm fluid)
- 4) Valve with ON / OFF servomotor (cold fluid)
- 5) Heat exchange battery (cold fluid)
- 6) Contact for condensate drip tray
- 7) Window contact

Heating and cooling with radiant systems



There are accommodation facilities in which floor or ceiling radiant systems are used for guest rooms, common areas or other rooms. Depending on the different situations, the operation of the radiant systems can be combined with that of fan-coil units, primary air or other systems that take over the functions of air renewal and dehumidification or integration of thermal loads.

Control with Ekinex

Considering a radiant floor system in the guest rooms, the room temperature is controlled by the EK-EQ2-TP room thermostat **(C)**, able of measuring temperature and relative humidity, in combination with the EK-HE1-TP actuator **(D)** and the EK-HC1-TP fan-coil actuator **(A)**.

The room thermostat **(C)** is able to calculate and send the dew temperature to the bus; in case the thermo-hygrometric conditions of the room are close to those critical for the formation of condensation on the cooled radiant surfaces, it is possible to implement one of the protection strategies provided by the Ekinex thermoregulation platform. The room thermostat allows the combined or separate operation of the two systems, radiant panels **(5)** and fan-coil unit **(1)**, possibly differentiated according to the season. It is possible, for example, to create a two-stage heating / cooling system in a simple way: the main stage is made up of the radiant panel system, the auxiliary stage by the fan-coil unit. The fan-coil, thanks to its very low inertia, contributes in the initial phase to quickly heat or cool the room and then stop its action when the demand for heat or cold can be satisfactorily dealt with by the main stage alone.

Application example (guest rooms, floor panels)

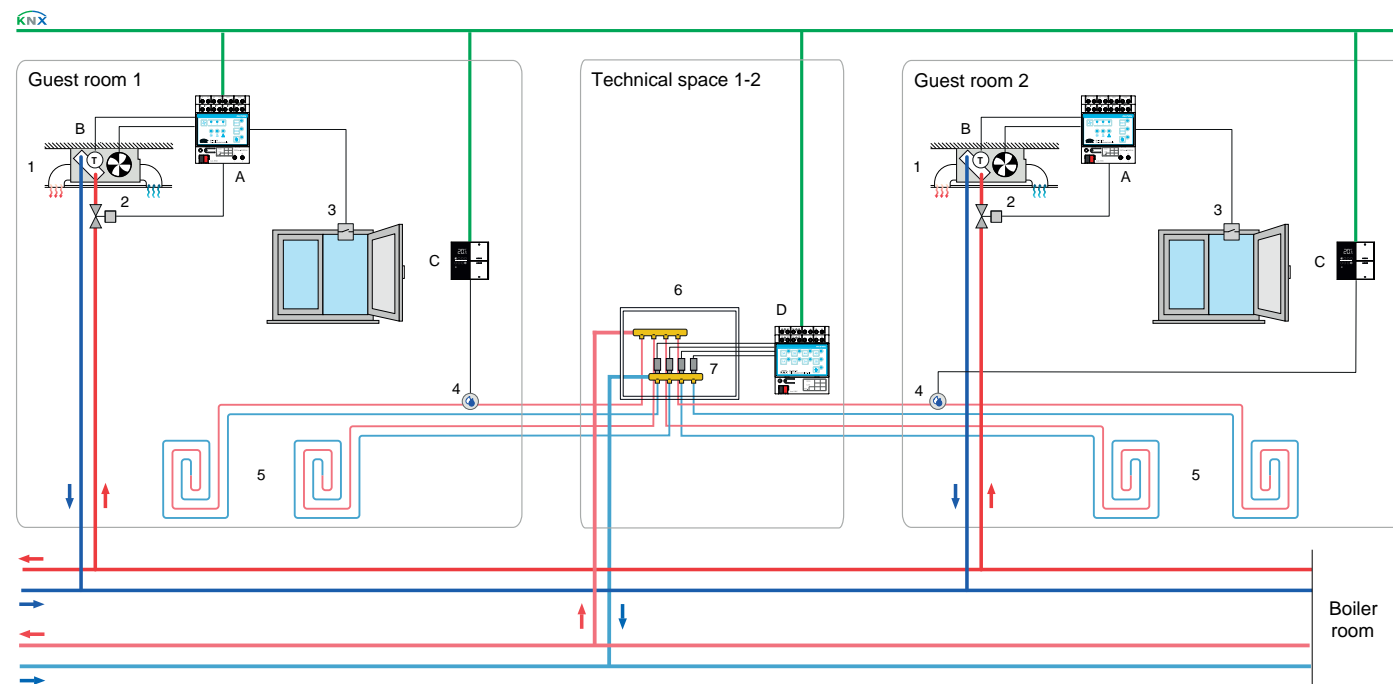

Ekinex devices

- A) Actuator-controller for fan-coil unit EK-HC1-TP
- B) NTC temperature sensor (contact) EK-STC-10K-3435
- C) Room thermostat EK-EQ2-TP
- D) Actuator-controller for electrothermal drives EK-HE1-TP

Other components

- 1) Fan-coil unit
- 2) Valve with ON / OFF servomotor
- 3) Window contact
- 4) Condensation sensor
- 5) Floor heating circuit
- 6) Distribution manifold for low-temperature circuits
- 7) ON / OFF electrothermal actuators

In many projects, radiant systems are chosen for their excellent integration with the architectural part and the high comfort offered: this is the case, for example, of the versions with ceiling panels **(6)**, used for meeting rooms, conference centres, staff offices or common areas. As in the case of the floor panels, the system is invisible and uses the entire ceiling surface as a large terminal for heat exchange. The air required for renewal and dehumidification can be sent into the room by means of special diffusers or distributed at low speed through the entire micro-perforated surface of the ceiling panels.

Control with Ekinex

When a 4-pipe hydronic system is used for heating and cooling rooms, in order to meet the complex requirements of the intermediate seasons and the high variability of thermal loads, the room air temperature can be regulated by means of the EK-ES2-TP multisensor **(D)** in combination with the EK-HE1-TP actuator **(B)** which controls the servomotors of the zone valves installed on the distribution manifolds. In addition to the function of room temperature controller, the multisensor **(D)** can measure and send to the bus the values of relative humidity, air quality (such as CO₂ and/or TVOC concentration) and dew temperature to the dehumidification and air renewal systems to ensure ideal comfort conditions in every situation. The operation of the system can be temporarily attenuated or stopped by detecting the status of door or window opening contacts **(7)** through the EK-CD2-TP interface **(C)**; the same interface can also detect



the signal of a condensation sensor **(5)**. To reduce the consumption of heating and cooling energy, the operating mode can be switched automatically depending on the presence of people in the room thanks to the EK-DF2-TP presence sensor **(E)**.

Application example (conference room, ceiling panels)

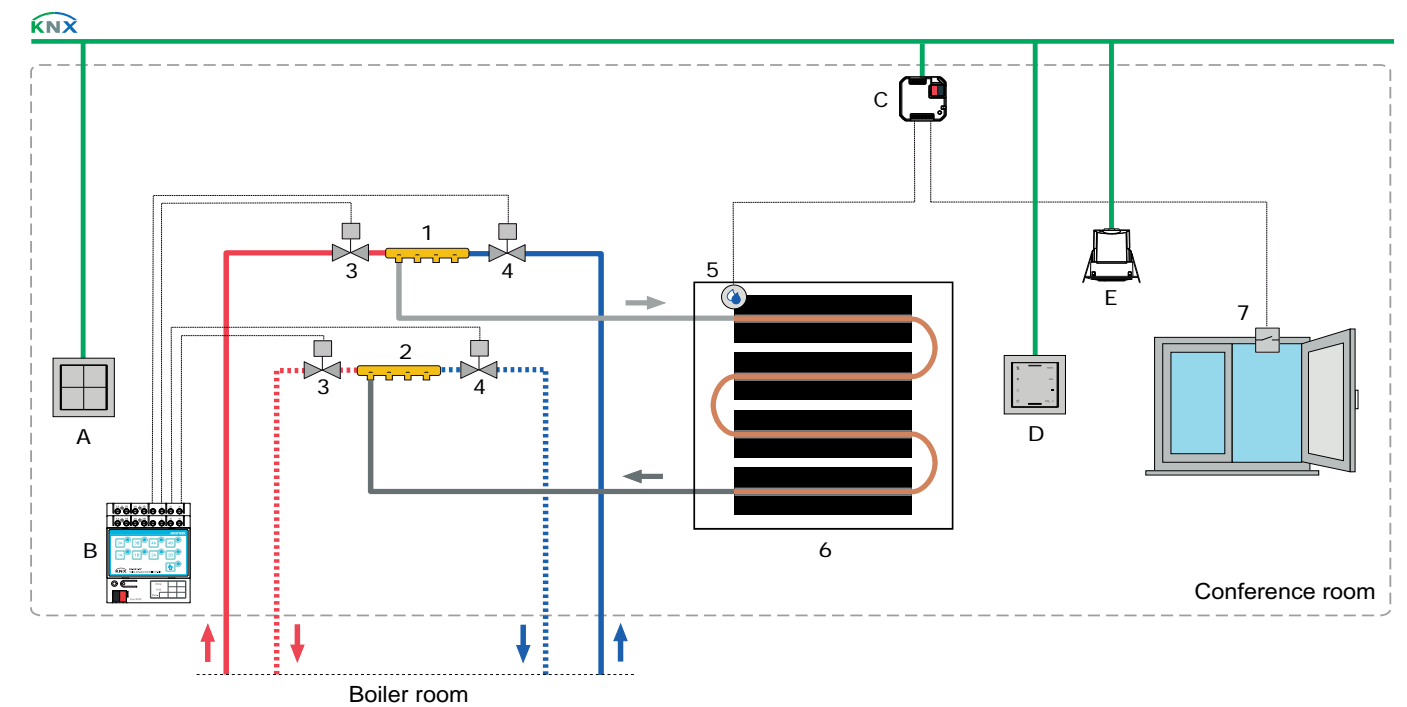

Ekinex devices

- A) Ekinex pushbutton (71 series)
- B) Actuator-controller for electrothermal drives EK-HE1-TP
- C) Universal interface EK-CD2-TP
- D) Multisensor (EK-ET2-TP or EK-ES2-TP)
- E) Presence sensor EK-DF2-TP

Other components

- 1) Distribution manifold (flow) for low-temperature circuits
- 2) Distribution manifold (return) for low-temperature circuits
- 3) Valve with ON / OFF servomotor (warm fluid)
- 4) Valve with ON / OFF servomotor (cold fluid)
- 5) Condensation sensor
- 6) Ceiling radiant panels (series)
- 7) Window contact

Ventilation and air renewal



In many accommodation facilities there are rooms, such as the restaurant, the conference rooms or the gym, which have special needs, because their occupation is highly variable over time: in fact, during the day there are periods in which they are poorly occupied, or even empty, and periods in which the room is occupied by many people within a few minutes and their stay can last for several hours. In these rooms ventilation and air renewal are of great importance: keeping the air quality and humidity level under control is essential to guarantee high comfort to the guests of the structure in every situation. For these needs, manual control alone or a simple scheduling are inadequate solutions. To ensure comfort and energy efficiency at the same time, it is necessary to use an "environmental" control by measuring one or more parameters and automatically adjust the fresh air flow rate to be introduced into the rooms according to occupancy levels.

Application example

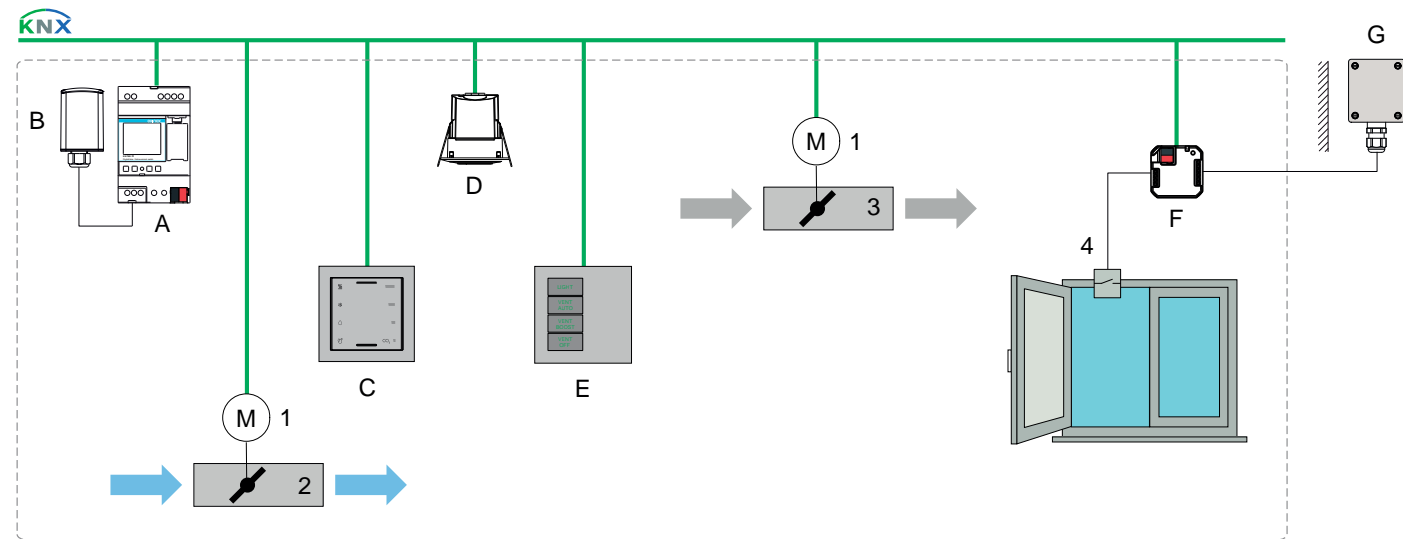

Ekinex devices

- A) Time / astronomical digital switch EK-TM1-TP
- B) GPS module EK-GPS-1
- C) Multisensor EK-ET2-TP or EK-ES2-TP
- D) Presence sensor EK-DF2-TP
- E) Ekinex pushbutton (20venti series)
- F) Universal interface EK-CG2-TP
- G) NTC temperature sensor (external) EK-STE-10K-3435

Control with Ekinex

The use of an EK-TM1-TP time switch (A), possibly with optional GPS module (B), makes it possible not only to give a consensus to the operation of the ventilation within predefined time slots, but also to activate the ventilation for a short period at maximum flow rate for a periodic cleaning of the room air before working hours. The multisensor (C) measures the most important environmental parameters for ventilation. The air quality is measured as concentration of carbon dioxide (CO₂) and total volatile organic compounds (TVOC); besides these parameters, relative humidity and temperature are measured. The use of an EK-DF2-TP presence sensor (D) is useful when a simplified automatic air renewal control is desired, by entering the design flow rate value when the room is occupied and ensuring instead a minimum flow rate value to save energy when the room is not occupied. During the summer season, if the outside temperature - measured with the EK-STE-10K-3435 temperature sensor (G) and acquired by the EK-CG2-TP universal interface (F) - is lower than the inside one, it is possible to operate the ventilation during the night to cool the rooms (free-cooling) with a minimum consumption of energy. The signal of a window opening contact (4), detected by the interface (F), allows temporary deactivation of ventilation and air handling to avoid wasting energy unnecessarily; reactivation occurs automatically when the window is closed. The pushbutton (E) allows to manually force operation if necessary: for example, activate the maximum flow rate ("boost" function) or switch the system OFF.

Other components

- 1) KNX servomotor for dumpers (not delivered by Ekinex)
- 2) VAV (Variable Air Volume) box for air supply
- 3) VAV (Variable Air Volume) box for air extraction
- 4) Window contact

Air quality

Whether it is a guest room, a fitness centre or a conference room, air quality is a prerequisite for an accommodation facility. Poor air quality, which often occurs indoors, is caused by pollutants from both inside and outside the building and the increased concentration of CO₂ due to human presence.

Ensuring high air quality is even more important since of buildings have been built or renovate in accordance with the legal provisions following the EPBD (2002/91/EC); in fact, with the aim of limiting heat loss to the outside as much as possible, buildings are now strongly insulated and equipped with airtight windows and doors. This increases energy efficiency, but makes buildings airtight. In these conditions, the manual opening of windows alone seems inadequate and exposes people to risks due to the increased concentration of pollutants emitted slowly but constantly by the synthetic products used in the construction sector and by the consumer products present in all buildings. If exposure to pollutants in indoor environments is prolonged over time, the problem is no longer just one of environmental well-being, but can also seriously affect people's health. It is therefore clear why it is important to take all necessary precautions to ensure high air quality.

Demand Controlled Ventilation (DCV)

If there is no automatic control, room ventilation can result in a significant energy cost. The control of air renewal through the building automation system makes it possible to combine high air quality with high energy efficiency.

Thanks to the many environmental parameters made available by the ekinex automation system, it is possible to carry out ventilation control according to the actual need for air renewal (a strategy known as DCV or Demand Controlled Ventilation). This allows to constantly adjust the air flow rate to be introduced into the rooms to the real needs with the aim of maintaining a constantly high air quality, while minimizing the energy consumption.

Using Ekinex for this purpose also means containing the number of sensors to be installed and using in a multifunctional way the devices and signal network already provided in the building for other functions, such as air conditioning, lighting or shading control.

With this type of control, energy is saved in two ways: the operating time of the fan units and the flow rate of fresh air to be treated - by heating, cooling, humidification and dehumidification before being introduced into the room - are reduced.

Multisensor with controller for T - R.H. - CO₂ - TVOC

The EK-ES2-TP multisensor (C) is a complete room climate control device that combines in a single product many functions usually distributed among several different sensors and controllers. The device measures temperature, relative humidity and air quality (parameters: CO₂ equivalent concentration in ppm and/or TVOC concentration in ppb) using the integrated sensors.



The measured values can be sent on the bus to other KNX devices or used by the integrated controller to control both thermo-hygrometric conditions and air quality with a single compact device.

In special cases, such as in large or very voluminous rooms, where there is a strong asymmetry in the temperature distribution or when the device is installed in an unsuitable position, the room temperature can be adjusted using a weighted average of two temperature values: the first one measured by the integrated sensor and the second one received by the KNX bus.

Two independent thresholds for relative humidity and three thresholds for air quality can be configured. To implement automation logic, AND, OR, NOT and exclusive OR logic functions are available; thanks to these, it is possible to use the information made available by the home automation system to control the air renewal according to the actual requirement (DCV, Demand Controlled Ventilation).

The device is also available in the EK-ET2-TP version with only CO₂ concentration measuring.

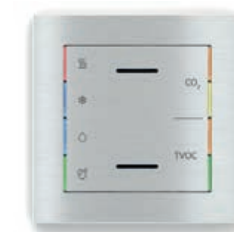

Control based on CO₂ or TVOC values

The choice of the control parameter depends mainly on the intended use of the rooms. Where the variability in the occupancy rate is very high or unpredictable (such as in meeting rooms, classrooms or small commercial environments) CO₂ is the most used indicator because its concentration is directly related to human activity and, in particular, to breathing. Although CO₂ is

not harmful to human health (except in very high concentrations, which are difficult to achieve), it has a direct impact on the concentration capacity and productivity of the occupants. When the number of people in the room is predictable and limited, the detection of volatile organic compounds (or VOC), a set of organic chemicals continuously emitted from furniture, paints, cleaning solvents, adhesives or other synthetic materials due to their high volatility, may be more significant.

Supervision



In order to give a character of exclusivity to the guests' stay, the suites differ from the standard rooms for the larger spaces, the greater offer of services, the state-of-the-art technology and the full possibility of control. The aim is to offer guests the highest level of comfort and well-being; this requires a more advanced and versatile automation that always maintains the ease of use and immediacy of understanding.

Control with Ekinex

In addition to traditional switches, controlling and monitoring of all functions of the suite can be carried out by Delégo supervision via a tablet (3) connected via Wi-Fi network to the EK-DEL-SRV Delégo server (A).

In the suites the lighting is more sophisticated: there are more luminaires; there is direct and indirect lighting; in addition to the luminaires (5) ON/OFF controlled by the EK-HO1-TP hotel module (D), there are LED sources (4) adjustable for intensity, colour or type of light which are controlled by the EK-GC1-TP LED RGBW dimmer (C); lighting scenarios are set up to take into account the time of the day or the use of the room, for example for moments of relaxation, work, reading or watching a film.

Likewise, the guest can fully control the shading through internal curtains and/or external roller shutters (9), heating / cooling and ventilation of the room (6). Where the hydronic system allows it, the guest can also switch between heating and cooling operation. All environmental parameters such as temperature, relative humidity and air quality can be displayed on the tablet (3), as well as outdoor conditions and weather forecasts. Finally, the guest can manage functions specific to hotel rooms, such as unlocking the entrance door (7), activating the "do not disturb" signal or calling the service personnel.

Application example (suite)

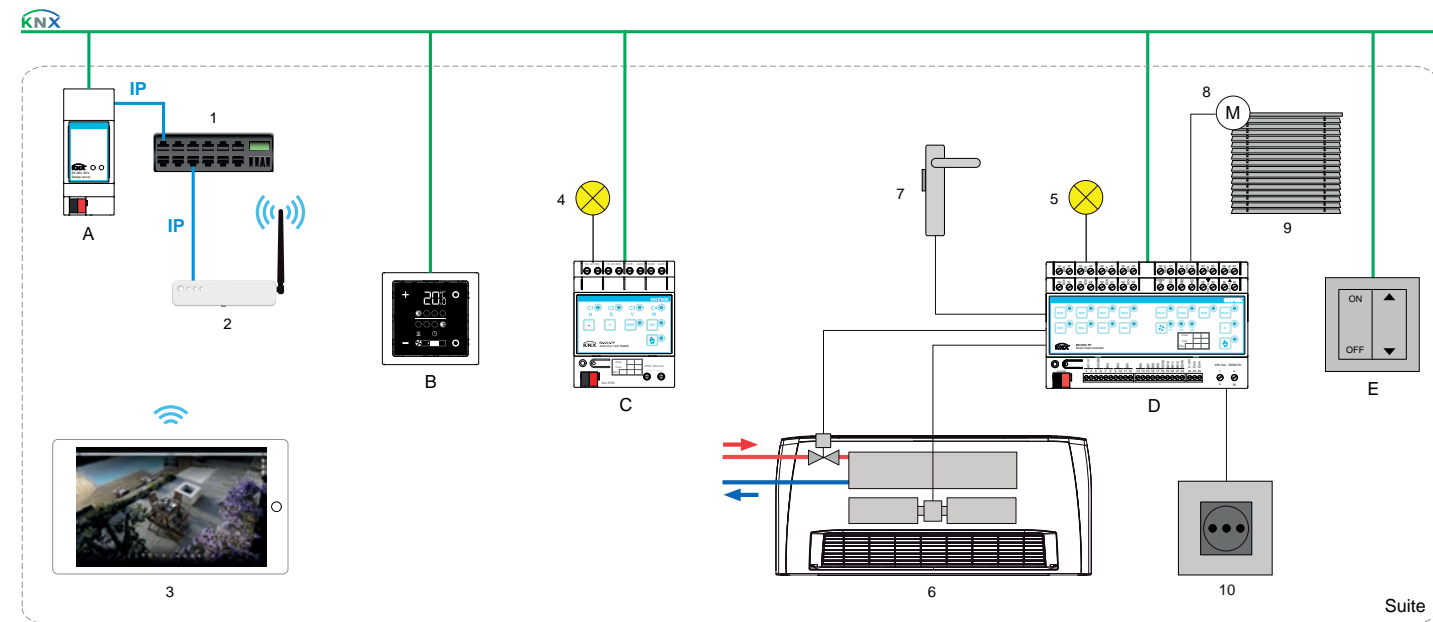

Ekinex devices

- A) Delégo server EK-DEL-SRV-...
- B) Room thermostat EK-E72-TP
- C) LED dimmer RGBW EK-GC1-TP
- D) Hotel module EK-HO1-TP
- E) Ekinex pushbutton (71 series)

Other components

- 1) Switch
- 2) Access point LAN Wi-Fi
- 3) Tablet with Delégo supervision
- 4) Luminaires with dimmable LED sources
- 5) Non-dimmable luminaires
- 6) Fan-coil unit
- 7) Electric door lock
- 8) Shading motorized drive
- 9) Shading devices (curtains, rolling shutters, venetian blinds)
- 10) Socket for electrical loads to be controlled

The conference rooms are an integral part of many accommodation facilities; one room, but with many possibilities of use as presentations, workshops, conferences or training courses. Besides the technical systems usually present in the facility, such as lighting, air conditioning and shading, in the conference rooms there are multimedia technologies; in these cases, the flexibility and interfaceability of the building automation system become fundamental. Another essential requirement is that the simultaneous control of many functions is simple and immediately understandable even to people who are not familiar with the different technologies and the room without having to resort to contact the staff of the structure. In these rooms, lighting control is particularly important in order to create the ideal atmosphere for each different need of use: it must always be comfortable, but also personalised according to the activity in progress. Depending on the circumstances, in fact, it is necessary to stimulate the participants' concentration or allow them to relax, to focus attention on the speaker or on what is projected on the screen.

Control with Ekinex

The control and monitoring of all conference room functions can be carried out by means of Delégo supervision; a Delégo touch panel (B), installed at the speaker's workstation, and a mobile device such as a tablet (3) can be connected to the EK-DEL-SRV Delégo server (A). In parallel, however, manual switches can also be provided, such as a pushbutton (D) for controlling shading near doors or windows.



Non-dimmable luminaires (5) can be ON/OFF switched using the EK-FE1-TP actuator (E) and dimmable luminaires can be controlled with dimmable LED sources (4) using the EK-GC1-TP RGBW LED dimmer (C). Combinations of switching and controlling of all functions can be easily grouped into scenes and recalled with a single touch from the Delégo supervision; this allows, for example, to coordinate the control of lighting (4, 5), beamer (9), projection screen (6) and shading (7), to use the natural light or screen it during projection.

Application example (conference room)

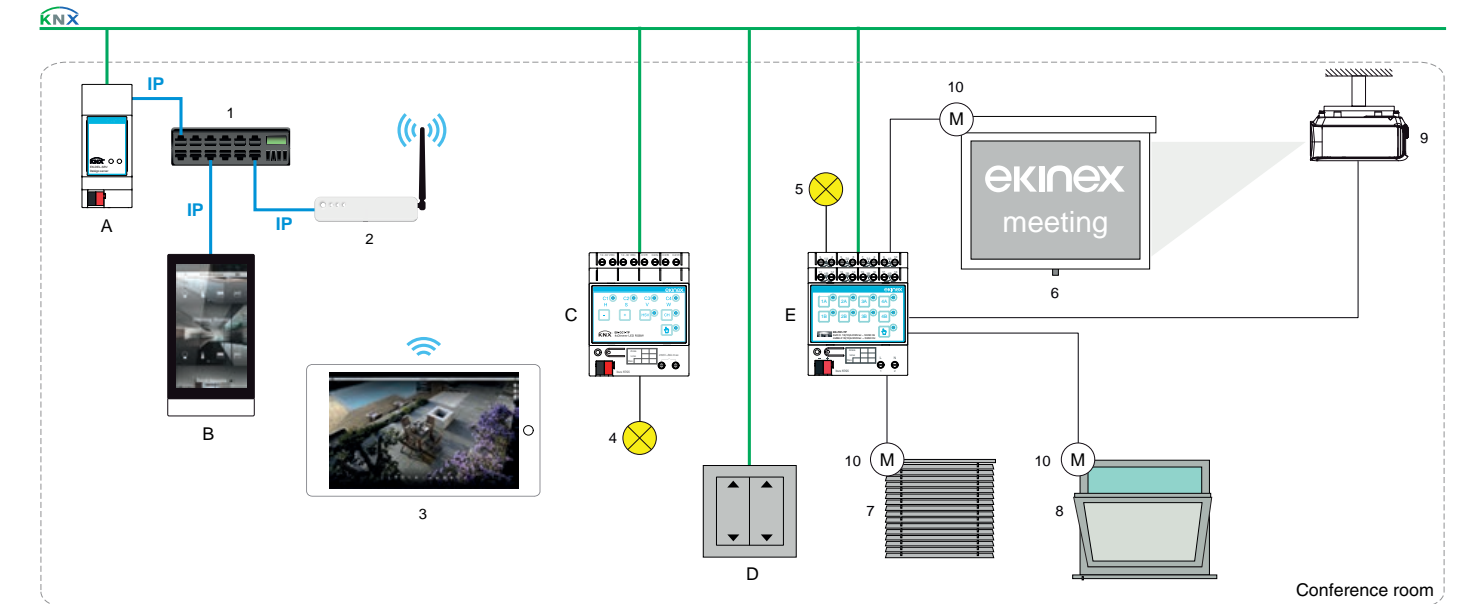

Ekinex devices

- A) Delégo server EK-DEL-SRV-...
- B) Delégo touch-panel (5" EK-DEL-5PAN or 8" EK-DEL-8PAN)
- C) LED dimmer RGBW EK-GC1-TP
- D) Ekinex pushbutton (71 series)
- E) Binary output / blind actuator EK-FE1-TP

Other components

- 1) Switch
- 2) LAN Wi-Fi access point
- 3) Tablet with Delégo supervision
- 4) Luminaires with dimmable LED sources
- 5) Non-dimmable luminaires
- 6) Projection screen
- 7) Shading devices (curtains, rolling shutters, venetian blinds)
- 8) Motorized window
- 9) Beamer
- 10) Motorized drive

Shading control and other drives

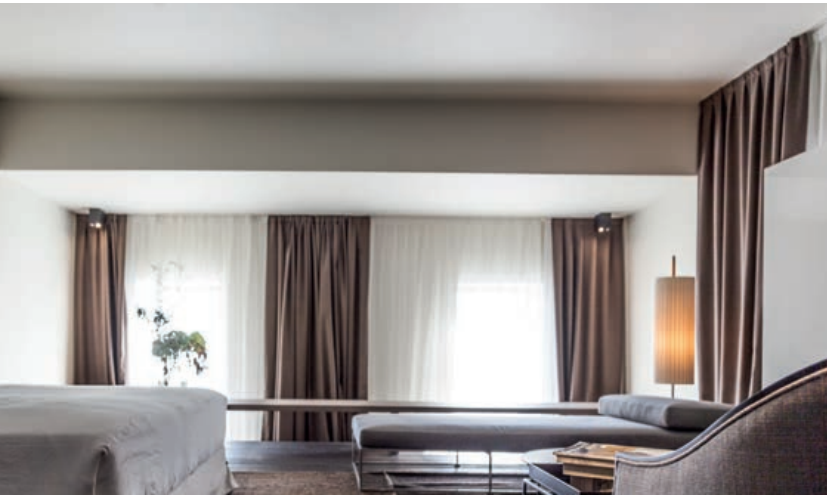

It is common experience that people spend their time more comfortably indoors when natural light is present. However, depending on the exposure of the façade, the size of the glass surfaces, the season or time of day, excess sunlight can easily occur, which can cause glare, annoying reflections on lighter surfaces or even room overheating. Integrating in the building automation system the control of sunscreens, shutters, venetian blinds or curtains, allows to avoid all these situations and always offer the best balance between the components of natural and artificial light, also reducing the cooling power required to the

air conditioning system in the summer season with positive effects on energy efficiency. In the accommodation facilities the control can take place automatically in the common areas, leaving instead to the guests full freedom to have the desired shading in the rooms through manual controls. In the conference rooms, the motorized control of the shading can be coordinated with that of the projection screen and the lighting, making it possible to always create the ideal conditions with the simple recall of a scenario.

Control with Ekinex

In the guest rooms the EK-H01-TP hotel module (A) can also be used as an actuator to control motorized drives (2) for the movement of shading devices such as roller shutters, venetian blinds or curtains (3) in combination with a pushbutton (B) from the Ekinex series. For operational safety, the window contact (1) - already used to automatically switch heating and cooling to stand-by when the window is opened - prevents any movement when the window is open. In the conference room, the blind actuator (D) (EK-FE1-TP 4-channel or EK-FF1-TP 8-channel) not only controls the motorized drives (2) for the movement of shading devices (3), but also raises and lowers the motorized projection screen (4) and opens / closes the windows (5). The control can be made with a double pushbutton (C) of the Ekinex series that can also recall scenarios that carry out a combination of commands and controls on all the automated functions of the room.

Application example

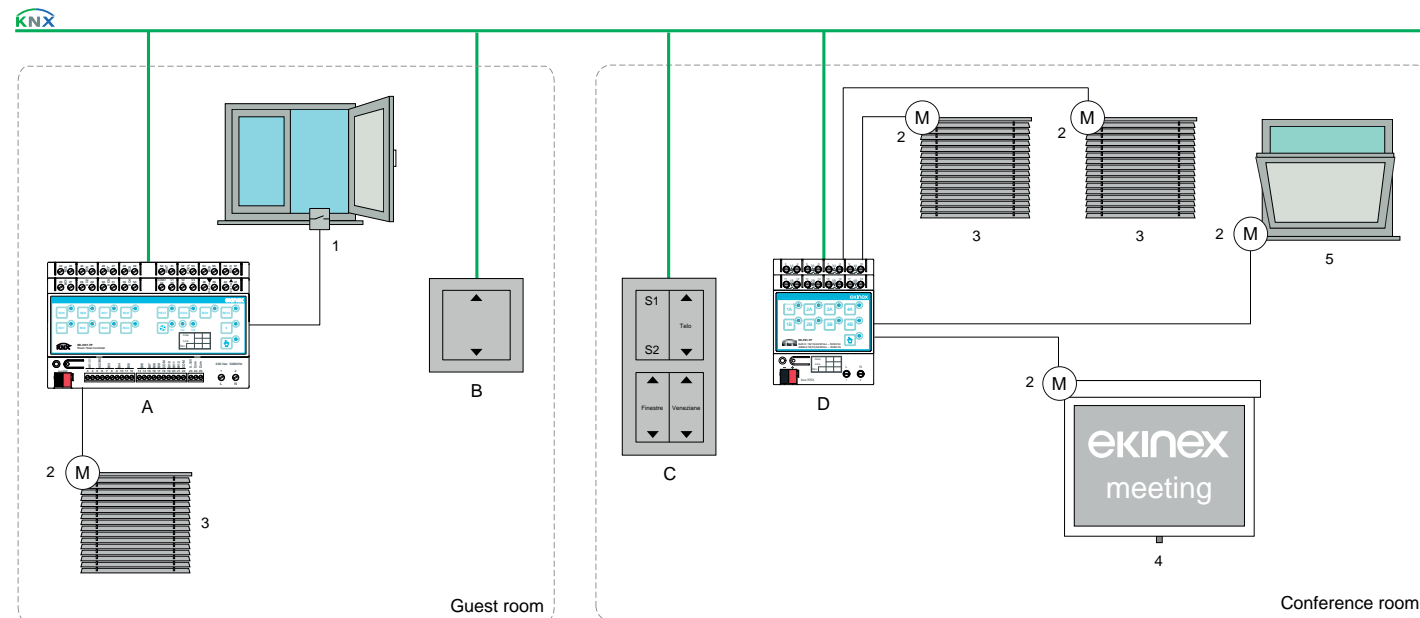

Ekinex devices

- A) Hotel module EK-H01-TP
- B) Single pushbutton (71 series)
- C) Double pushbutton (71 series)
- D) Binary output / blind actuator EK-FE1-TP

Other components

- 1) Window contact
- 2) Motorized drive
- 3) Shading devices (curtains, shutters, venetian blinds)
- 4) Projection screen
- 5) Motorized window

Voice control

In recent years, voice assistants integrated in the home speakers have established themselves not only for interaction with the web, but also as an easy and intuitive control interface for smart buildings.

Voice control offers the possibility to control the several room functions in the most natural and immediate way possible. For many users it can be even simpler than a smartphone app, as it does not require them to read selection menus or understand graphic symbols: they simply pronounce the action to be taken. Even in accommodation facilities there are rooms and users who can take advantage of it: voice control can make more accessible systems and technologies whose use is experienced as too demanding by end users who are unfamiliar with technology.

Control with Ekinex

The Ekinex interface for home speakers allows the most popular voice assistants to interact with the building automation system. Thanks to the device, all KNX devices of the Ekinex range can be interfaced and a multitude of functions, such as lighting, heating, cooling, ventilation or shading control, can be controlled via simple voice controls.



Application example

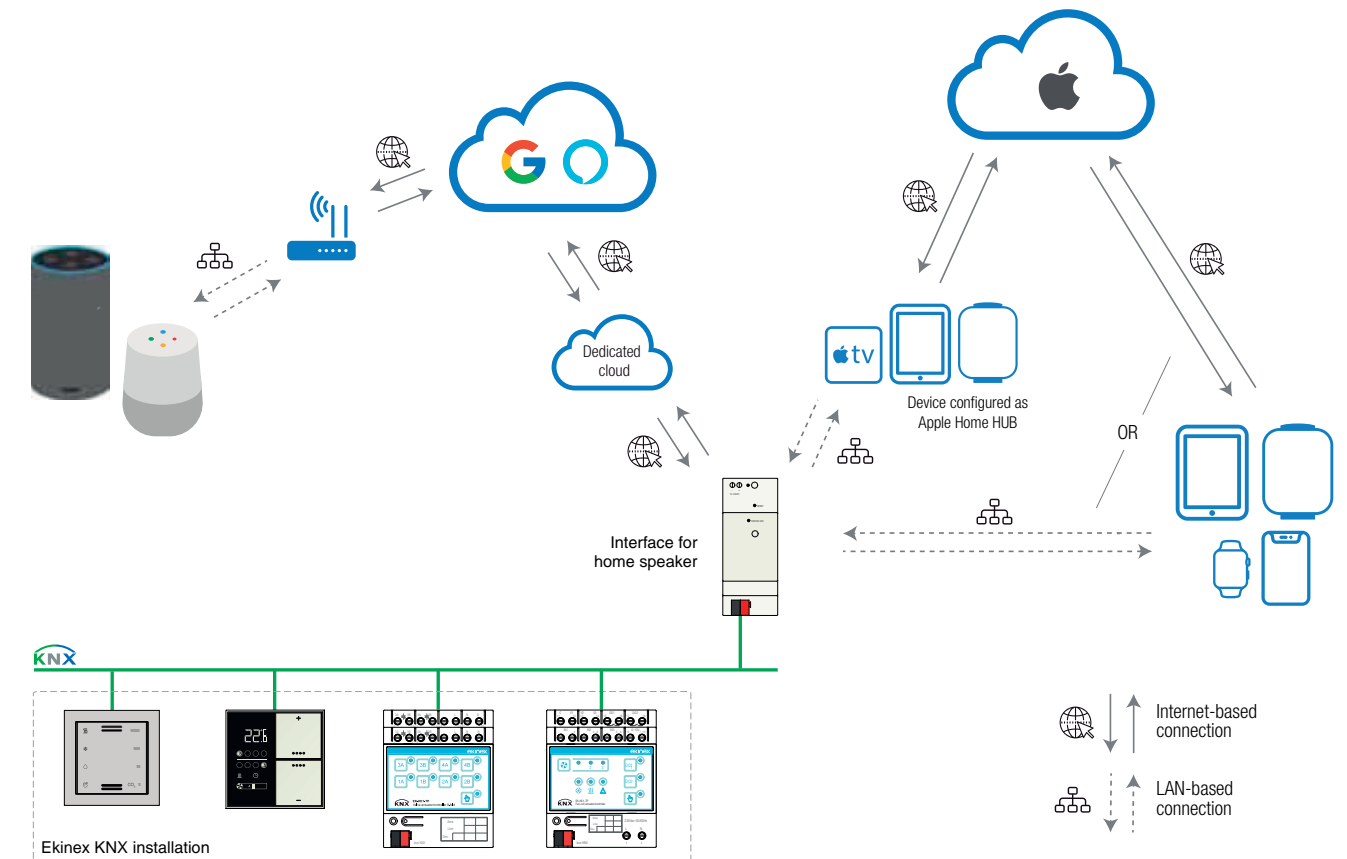

Monitoring of technological systems



The monitoring and supervision of the technological systems plays a fundamental role in the accommodation facilities: in fact, it is absolutely essential to guarantee to the guests a high level of service and maximum continuity of operation of the systems.

According to the individual needs of a hotel building, the system allows to keep under control a set of values, parameters, states and quantities relevant to the operation of the various technical systems: the comparison with the design and standard reference values allows to highlight any anomalies, analyze deviations and quickly restore optimal operation. The inclusion of technical alarms in the system is decisive for the timely intervention of service and maintenance staff.

The integration between the monitoring of technological systems and the building automation system offers the possibility to increase the efficiency in the use of resources, reducing waste, to fully exploit the potential of technological systems, to limit the need for technical inspections and to allow a longer life of individual components or complex equipment.

Thanks to the centralization and information available in real time, it is easier for the staff of the hotel to identify problems on the synoptic diagrams and the subsequent reporting to the technicians responsible for assistance. This is particularly important for those hotels distributed among several buildings with a multitude of technical rooms and substations.

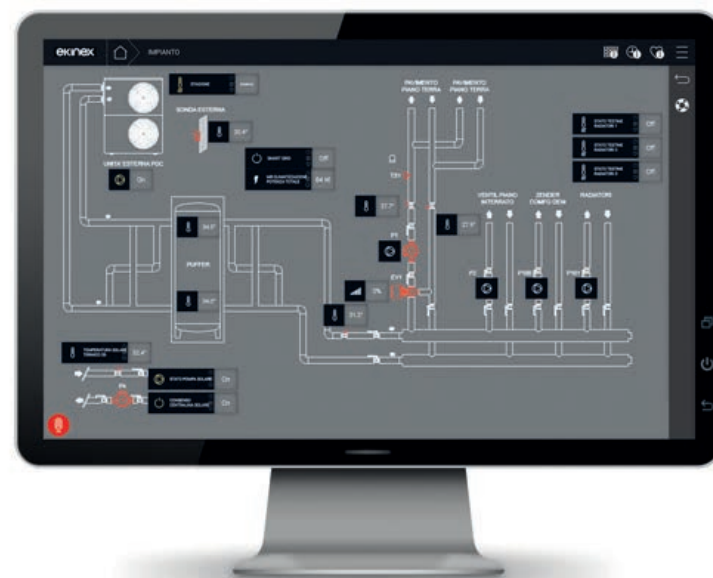

Consumption monitoring

When running and managing an accommodation facility, it is particularly important to have consumption data, whether electrical, thermal or water consumption. First of all, this allows to avoid waste and reduce unnecessary consumption, increasing efficiency in the use of resources. At the same time, anomalies can be detected that indicate the need to maintain or replace a system component. Secondly, the cost controlling can assess how costs are generated among the different departments or cost centres of the facility: e.g. guest rooms, restaurant and bar, swimming pool and sauna, fitness area and wellness centre or conference rooms and calculate the profitability of the different activities carried out. Finally, actual consumption values can be compared with project values or branch benchmarks, especially for hotels designed as green buildings. In hotel buildings subject to sustainability certification, the measurement of consumption also makes it easier to obtain a series of credits that improves the overall rating. As far as HVAC systems are concerned, the measurement of consumption is particularly important, since in hotel buildings heating, cooling, ventilation and sanitary hot water production almost always represent the most important share of final energy consumption.



If the building is provided with solar energy capture systems, it is also possible to know the data of thermal and/or photovoltaic energy production and to evaluate the overall degree of energy self-sufficiency of the building.

Application example

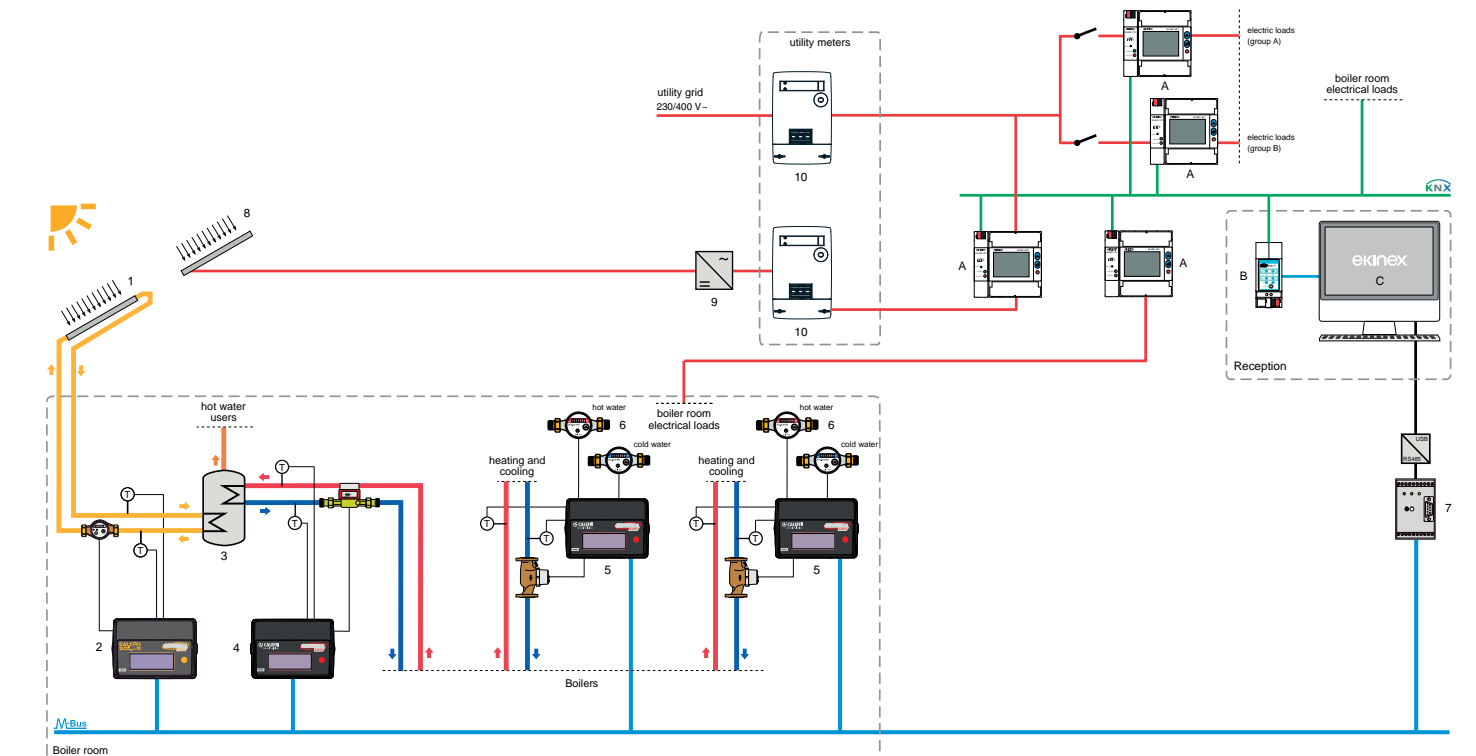

Ekinex devices

- A) Energy meter with KNX communication module EK-MC1-TP
- B) KNX / IP router EK-BC1-TP
- C) Supervision software

Other components

- 1) Heat solar panels
- 2) Heat meter (solar system)
- 3) Hot water storage tank
- 4) Heat meter (for sanitary hot water)
- 5) Heat meter (for heating / cooling)
- 6) Hot and cold water meters
- 7) M-Bus power supply
- 8) Photovoltaic solar panels
- 9) Photovoltaic inverter
- 10) Energy meter (utility)

.....

INFORMATION

.....

Topics	
Energy efficiency	62
neZEH - nearly Zero Energy Hotel	62
Indoor Environmental Quality (IEQ)	63
Certified sustainability	63

Planning tools	
Ekinex planner	64
BIM	65

Energy efficiency

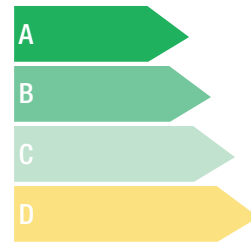

Hotels are among the top five types of buildings in the services business for the energy consumption. A typical hotel consumes about 320 kWh/m² per year and releases between 160 and 200 kg of CO₂ per square meter of room area.

In hotels, the largest user of energy (about half of total consumption) is the room conditioning, which usually includes heating, cooling, ventilation,

renovation and dehumidification. As can be expected, the external climatic conditions and the characteristics of the building envelope are the main factors determining the amount of energy required for air conditioning. But the internal temperature levels are also decisive for energy consumption. Full control of the room thermostats and terminal units by guests often leads to unnecessarily high temperatures in winter and low temperatures in summer. Windows and doors can remain open when the air conditioning system is running at full power. Moreover, in many rooms guests are absent during the day (even 60-65% of the time), while the systems are left on: it may happen that the air conditioning energy of a room is consumed for 24 hours a day or that the system remains active even without a reservation. In these cases the potential for energy savings is considerable, especially considering that in these buildings much of the energy consumption is due to losses and waste. But energy savings cannot sacrifice the comfort of guests. For this reason, the use of building automation is essential, both for new buildings and for renovations.

Class A: includes buildings with high energy performance, equipped with control and automation systems (BACS) and technical plant management (TBM) characterized by high levels of accuracy and completeness of automatic control.

Class B: this includes energy advanced buildings, with control and automation systems

(BACS) and technical plant management systems (TBM) that allow centralised control.

Class C: includes standard buildings from the energy point of view, equipped with control and automation systems (BACS) with basic functionality. It is also the class used as a reference for calculating efficiency factors.

Class D: includes buildings that are not energy efficient and have only traditional technical systems, without any automation.

References

EN 15232-1:2017 Energy Performance of Buildings - Energy performance of buildings - Part 1: Impact of Building Automation, Controls and Building Management

neZEH - nearly Zero Energy Hotel



The concept of NZEB or "Nearly-Zero Energy Buildings" was introduced by the European Directive on the energy performance of buildings (2010/31/EU). This term refers to a building with very high energy performance, in which the energy demand is very low or almost zero and should be covered to a very significant extent by energy from renewable sources, including energy

produced locally or nearby. From 31 December 2018, new buildings occupied by (and owned by) public authorities must be nearly zero-energy buildings, while from 31 December 2020 all new buildings must be nearly-zero energy buildings.

The neZEH project

From 2013 to 2016 the European Commission co-funded the neZEH (Nearly Zero Energy Hotel) project with the aim of demonstrating the benefits of converting existing hotel facilities into nearly-zero energy buildings and accelerating their renovation rate. Through pilot projects the feasibility of these investments was confirmed, providing technical advice to hoteliers, undertaking training activities and promoting communication campaigns to raise awareness of the benefits of NZEB buildings and convince European hoteliers to invest in energy efficiency projects.

The results

The project involved the renovation of sixteen hotels located in seven European countries (Croatia, France, Greece, Italy, Romania, Spain and Sweden) to become NZEB buildings with an investment of € 6.3 million. The production of renewable energy has reached the equivalent of 332 toe/year, achieving a primary energy saving of 1.123 tOe/year with a consequent reduction of CO₂ emissions of 2.556 t/year. Practical tools were made available online including the neZEH e-toolkit to enable hotels to assess their energy consumption and identify solutions for improving energy efficiency. For more information about the neZEH project: www.nezeh.eu

References

Directive 2010/31/EU of the European Parliament and of the Council of 19 May 2010 on the energy performance of buildings (recast)

Commission recommendation (EU) 2016/1318 of 29 July 2016 on guidelines for the promotion of nearly zero-energy buildings and best practices to ensure that, by 2020, all new buildings are nearly zero-energy buildings

Indoor Environmental Quality (IEQ)

The legislative and standard framework for building design has evolved profoundly since the early 2000s. The European Union has drawn attention to the fact that buildings are responsible for 40% of final energy consumption - and 75% of them are still energy inefficient - requiring Member States to make a major recovery of efficiency through mandatory transposition directives. On the other hand, this action must not decrease the comfort and well-being of the end-users of buildings, also considering the high proportion of time spent indoors. The concept of Indoor Environmental Quality (IEQ) has therefore been affirmed, underlining the importance of ensuring high environmental quality within confined spaces, together with the recovery of energy efficiency. This is a comprehensive approach in four dimensions:

- thermo-hygrometric comfort;
- air quality;
- visual comfort;
- acoustic comfort.

The first three dimensions are directly influenced by the level of automation and control of the building chosen by clients and designers.

The quality of the indoor environment is extremely important for an accommodation facility and has a direct link with the comfort and well-being experienced by guests: the right atmosphere translates into a pleasant experience, a prolonged stay and a probable

return of guests to the same facility. In 2008, the IEQ concepts were recognised with the publication of EN 15251 standard, which was replaced in 2019 by EN 16798-1 standard.

References

EN 16798-1:2019 Energy performance of buildings. Ventilation for buildings. Indoor environmental input parameters for design and assessment of energy performance of buildings addressing indoor air quality, thermal environment, lighting and acoustics - Module M1-6

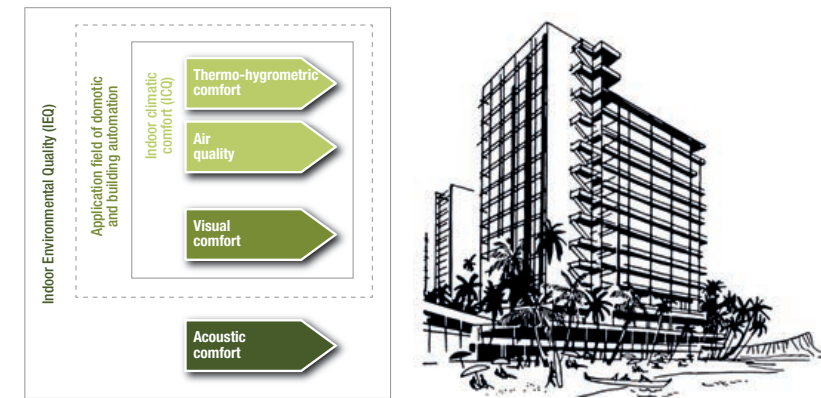

Certified sustainability

As time goes by, more and more projects of buildings are submitted to sustainability certification. The concept of "sustainability", which is now common in many sectors, was defined in the "Our Common Future" report (known also as Brundtland Report) published in 1987 by the World Commission on Environment and Development.

Sustainable development is a process that ensures "that the needs of the present generation are met without compromising the ability of future generations to meet their own needs". In this sense, sustainability must ensure compatibility between development and environmental protection.

An increasing number of entrepreneurs in the hotel sector require a building sustainability certification on their own initiative, also because of the growing sensitivity of guest-customers and the awareness of tour operators who carefully evaluate the environmental impact of their choices. Customers in the coming years will prefer hotels equipped with efficient energy and water systems, high quality interiors in terms of comfort and well-being, a high degree of reuse of resources, easy access to public transport or a wide range of organic and locally grown food. This is a virtuous dynamic that will stimulate the continuous improvement of the hotels with positive effects for both guests and managers. In this context, hotels that achieve an internationally recognized sustainability certification differ significantly from other facilities, testifying to their commitment to the environment.

There are several sustainability certification schemes, such as LEED, BREEAM, Greenstar and DGNB. In all these cases, building projects that are subject to certification may receive points in different categories, depending on whether they meet the corresponding requirements; these may include location and transport; site; water efficiency, energy and atmosphere; materials and resources; internal environmental quality; innovation; and much more. Depending on the number of credits achieved, a project obtain one of the levels of evaluation required by the certification scheme. In addition to the design



and construction phases, in the case of hotels, certification schemes take particular account of the management and maintenance phases, which must be in line with best sustainability practices.

To achieve a high rating in sustainability certification, a very important role is played by the building automation and control system. In the case of LEED* (Leadership in Energy and Environmental Design) for example, the use of the KNX system can contribute to obtaining up to 54 credits** out of a maximum of 110 provided for in the certification. 80% of the credits to which KNX contributes concern three important LEED categories: energy and atmosphere, indoor environmental quality and water efficiency.

*) Developed by U.S. Green Building Council (USGBC)

**) KNX for LEED, 2013, Jesús Arias García, Miguel Ángel Jiménez Ibaricu, KNX Association cvba (Bruxelles)

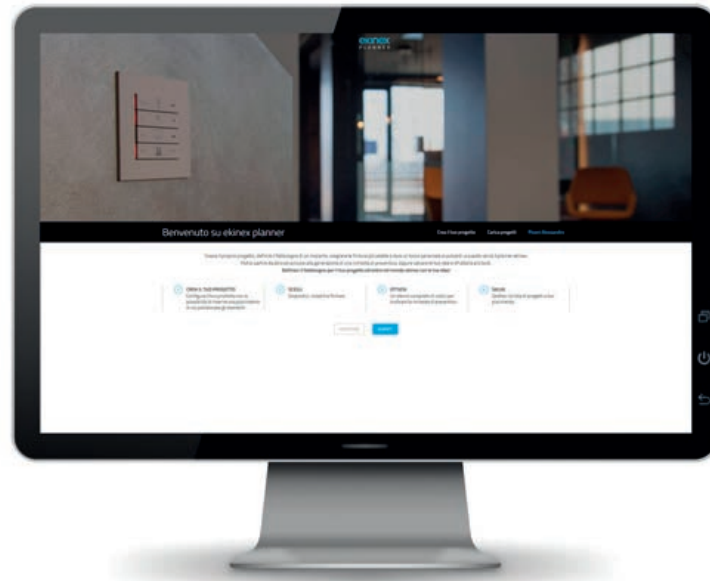

Description

PLANNER is a configuration software made available on its website from Ekinex®. This tool, from the easy to use and driven, allows the end user and the designer to identify products that are perfectly suited to the needs of the project. With PLANNER you can also choose and test different combinations of buttons and civil series finishes to get closer as possible to the desired result. PLANNER allows you to fill out a simple list of devices to be used or they can be placed in a preview of a user-uploaded file, in order to recreate the actual conditions of the future installation. Finally, the software allows you to create a database of your projects with the ability to retrieve and modify projects at all times. When you finish using PLANNER allows you the chance to ask Ekinex® the best trade offer to the list of materials in your project

Use in 4 steps

1) ADD A PROJECT

From the Ekinex® site, reach PLANNER by following this link: planner.ekinex.com/en/. At this point you can decide whether or not to insert a map (jpeg, gif, png, pdf image format); in any case you will be asked to give a name to your project, so that you can identify it later.

2) SELECT DEVICES, MODELS AND FINISHING

PLANNER guides you on the page where you can find a list of products and create a list of devices to be installed in the system. All the wall-mounting and rail-mounting products can be placed on the image of the plan if previously inserted.

3) GET THE LIST

PLANNER gives you the ability to export and manage the list of chosen devices, to be able to control the features chosen.

4) SAVE THE PROJECT

By clicking on "save changes", you will save the positions and changes made. You can also print the project and export the list of products in pdf format.

Planner

TOOLS

Offer request

Planner is a great business tool. You can request this offer and conditions for devices of your project directly in the "PROJECT CONFIGURATION" by clicking on "request a quotation". The network of Ekinex® will contact you and will answer quickly and with the best offer for your project.

For further information contact: sales@ekinex.com

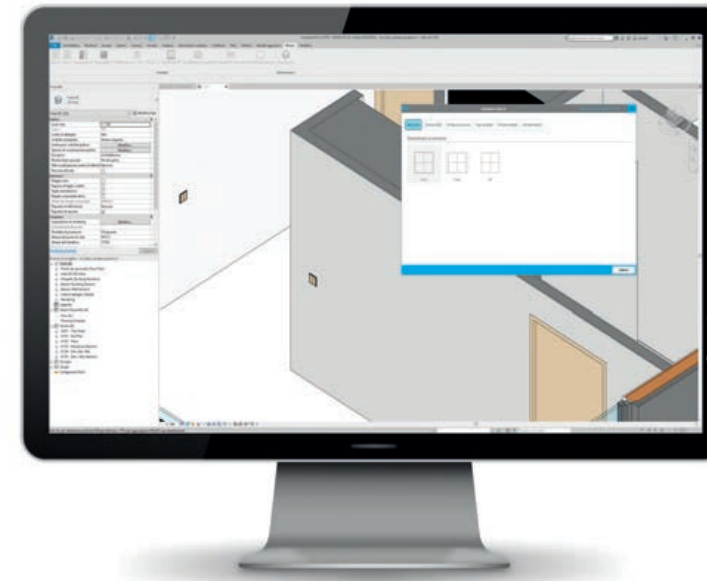

Description

BIM stands for Building Information Modeling and indicates a methodology aimed at optimizing and managing the design and construction of a building.

The BIM is therefore used mainly in the construction sector to promote a working method that involves the generation of a building model that can also manage the data of the entire life cycle through multi-dimensional virtual models generated digitally by means of specific software.

A BIM can contain any information about the building and its parts. The most commonly collected information is geometry, technical and mechanical data, electrical data, material specifications, financial, energy and environmental assessments.

What are the benefits of BIM in home automation and construction?

The role of BIM in the construction industry is to support collaboration between the different actors involved (designers, builders, architects, clients) and integrate the design and simulation processes into a single model that can manage all phases of the life cycle of the building.

The main benefit of adopting the BIM methodology is the 3D representation during the design phase, which speeds up processes, reduces delivery times and allows errors and inaccuracies to be detected first. The greater efficiency in sharing information and a more precise control over all the processes involved, also make it possible to contain costs and schedule in advance maintenance operations.

The fields of BIM related to technology allow the management of complex projects such as home automation and the willingness of the customer to control the building. During the design phase it is already possible to simulate the integration of the different systems and the control of the possible scenarios in a 3D environment, giving all the professionals involved the opportunity to work together without data or process conflicts.

BIM

TOOLS

Software

The BIM library is available in Autodesk Revit® format, by installing our **Ekinex BIM Content Creator software**, a real advanced configurator of the product range that will be enriched with future updates and expansions.

For further information:

en.ekinex.com/bim/library-wall-mount.html

en.ekinex.com/bim/bim-library-rail-mounting-devices.html

Hotel Solutions - June 2020

The technical information contained in this catalogue is purely indicative. The company reserves the right to make changes without notice.

The diagrams show some examples of use of the Ekinex® devices developed according the KNX standard, are made with simplified symbols and report only the system components relevant for the control and automation with Ekinex® devices. For the design, installation and commissioning of Ekinex® devices and systems, please contact qualified professionals.

For installation, connection and commissioning of Ekinex® devices refer to the technical documentation.

For availability of Ekinex® products on your market, please contact the Ekinex® sales department (sales@ekinex.com).

© EKINEX S.p.A. 2020. Reproduction of parts of the catalogue is only possible with the prior written approval of EKINEX S.p.A.

Credits

Creative Manager	Ekinex® Marketing & Communication
Graphical project	Ekinex® Marketing & Communication
Contents	Ekinex® Business Development
Printing	Tipolitografia Testori Snc

CATHOSEK0620EN

Contacts

Ekinex S.p.A.

Via Novara, 37
I-28010 Vaprio d'Agogna NO - ITALY
T +39 0321 1828980
info@ekinex.com
www.ekinex.com



www.ekinex.com